



Commander II Series

The Powerful Difference

Manual

Product Compliance



RoHS

Copyright © NewMar 2021 All rights reserved.

Manual Version 1.1

Release Date: 30 JUL 2022

Disclaimer: NewMar reserves the right to make changes to the information within this document without notice

M-CMDRII 063022

Table of Contents

1	Admonishments	5
2	Safety	5
3	Receiving Instructions	6
3.1	Package Inspection	6
3.2	Equipment Inspection	6
3.3	Handing	6
3.4	Identification Labels	6
4	Scope	6
5	System Overview	7
5.1	Power System	8
5.1.1	Standard Features	8
5.1.2	Additional Features	8
5.1.3	Physical Dimensions and Weight	9
5.2	Energy Manager	9
5.2.1	EM4x-01 Interface	9
5.2.2	Alarms and Status Indicators	10
5.2.3	Energy Manager 3U Touchscreen	10
5.2.4	EM4x Features	10
5.3	Rectifier Modules	11
6	Installation	12
6.1	Required Tools	12
6.2	Suitable Racks	12
6.3	Unpacking	13
6.4	Installing the Commander II and II+ System	13
6.5	Rectifier Module Insertion and Removal	16
6.6	Ventilation	17
7	Energy Manager Connectivity and the Web UI	17
7.1	Access Levels	17
7.2	Ethernet Port Connection	17
7.3	USB Connection	18
7.4	Energy manager and & IO PCB Alarm Configuration	19
7.4.1	EM4x Alarm Mappings	19
7.4.1.1	EM4x Red LED Urgent Alarm Mapping	20
7.4.1.2	EM4x Yellow LED non-Urgent Alarm Mapping	20
7.4.2	EM4x Main PCB Alarm Mappings	20
7.4.3	EM4x Main PCB Digital Input Alarm Mappings	21
7.4.4	Circuit Breaker Fail Monitoring	21
8	LVD Operation	22
9	Maintenance	22
9.1	System	22
9.2	EM4x Controller	22
9.3	Rectifiers and Converters	22
9.4	Batteries	23
9.5	Ventilation Maintenance	23
10	Troubleshooting and Servicing	23
10.1	Servicing	23
11	Essential System Setup Parameters	24

11.1	Systems with Lead Acid Batteries	24
11.1.1	Check the Battery Type	24
11.1.2	Check/Set Float Voltage	24
11.1.3	Set Battery Temperature Compensation	24
11.1.4	Set Battery Capacity	25
11.1.5	Set Batter Current Limit	26
11.1.6	Low Voltage Disconnect Settings	27
11.2	DC System Lead Acid Battery Commissioning Checklist	27
11.3	Systems with Lithium Batteries	31
11.3.1	Check the Battery Type	31
11.3.2	Modular Smart Lithium Battery Selection	31
11.3.3	Check/Set Float Voltage	31
Appendix I	Rectifier Fuse and front panel behavior	31
II.A	Rectifier Input Fuse Characteristics	31
II.B	Rectifier RM3048HE Front Panel Indications	32
II.C	DC-DC Convertor Front Panel Indicators	33
Appendix II	AC Input Transient Protection	33
II.A	Upstream Over-Current Protection	34
II.B	Cable Rating	34
II.C	Discrimination	34
II.D	Surge Suppression Device Protection	34
II.E	AC cable installation and surge protection	34
Appendix III	Warranty Exclusions and Restrictions	36
III.A	Battery Warranty	38
III.B	Initiating a Warranty Claim	37
III.C	Disclaimer	37
III.D	Remark	37
Appendix IV	System Schematic	39

Table of Figures

Figure 1: Commander II & Commander II+	7
Figure 2: Em4x-01 Front Panel Interface	9
Figure 3: Energy Manager 3U Touchscreen	10
Figure 4: RM3048HE Rectifier	11
Figure 5: Removing the Top Cover	13
Figure 6: AC Earth Termination	12
Figure 7: AC Earth Termination	12
Figure 7A: External Earth Termination	12
Figure 8: Connecting the load	12
Figure 8A: Connecting the load	13
Figure 9: Connecting the battery	13
Figure 10: Cable Management	14
Figure 11: Securing the Top Cover	15
Figure 12: Battery Connections	16
Figure 13: Controller Layout	17
Figure 14: RM3048HE Front Panel	18











Figure 15: Inserting a Rectifier	18
Figure 16: Removing a Rectifier	19
Figure 17: Energy Manager Ethernet Port	20
Figure 18: EMX4x-01 Front Panel micro-USB	20
Figure 19: EM4x Relay Outputs	23
Figure 20: Rectifier Input Fuse Tripping Curves	33

List of Tables









Table 1: Commander II & II+ dimensions and weights	9
Table 2: IO Board 1 Relay Alarm Assignments	23

1 ADMONISHMENTS

The admonishments are the symbols and wording used in this manual to alert readers to specific dangers and instructions. The meanings of the various admonishments are explained as follows:

- Warning** = risk to life or personal injury and equipment damage
- Caution** = risk of equipment damage.
-  = risk of electrical shock potentially causing death or injury.
-  = alert of risk potentially causing death or injury.
-  = risk of burn injury from hot surfaces
-  = an alert that must be understood and undertaken.
-  = instruction of mandatory reading of product manual.
-   = risk of electrostatic damage to components. Proper precautions must be taken.
-  = access for children prohibited.
-  = restricted access area.
-  = tip over hazard.

2 SAFETY

-   All installation and maintenance must be carried out by suitably qualified personnel.
-   For your protection, the product manual should be read and thoroughly understood before unpacking, installing and using the equipment.
-   The energy manager contains static sensitive components that require careful handling and proper precautions to be taken. A grounding strap should be worn.
-   The equipment is intended only for use in a restricted access area. The equipment is not suitable for use in locations where children are likely to be present.

3 RECEIVING INSTRUCTIONS

NewMar provides all equipment to the delivering carrier securely packed and in perfect condition. Upon acceptance of the package from NewMar, the delivering carrier assumes responsibility for its safe arrival. Once the equipment is received, it is the recipient's responsibility to document any damage the carrier may have inflicted, and to file the claim promptly and accurately.

NOTE: the period to make a claim against damage by a transport carrier can be short, a matter of days, and varies by transport method, the transport contract, and local laws.

3.1 Package Inspection

Examine the shipping crate or carton for any visible damage: punctures, dents and any other signs of possible internal damage.

Describe any damage or shortage on the receiving documents and have the carrier sign their full name.

3.2 Equipment Inspection

Open the crate or carton and inspect the contents for damages. While unpacking, be careful not to discard any equipment, parts or manuals. If any damage is detected, call the delivering carrier to determine the appropriate action. They may require an inspection.

NOTE: Save all the shipping materials for the inspector to see.

After the inspection has been made, if damage has been found, contact NewMar. We will determine if the equipment should be returned to our plant for repair or if some other method would be more expeditious. If it is determined that the equipment should be returned to us, ask the delivering carrier to send the packages back at the delivering carrier's expense.

If repair is necessary, we will invoice you for the repair so that you may submit the bill to the delivering carrier with your claim forms.

It is your responsibility to file a claim with the delivering carrier. Failure to properly file a claim for shipping damages may void warranty service for any physical damages later reported for repair.

3.3 Handling

Handle the equipment with care. Do not drop or lean on front panel or connector. Keep away from moisture.

3.4 Identification Labels

Model number and serial number are clearly marked on all equipment. Please refer to these numbers in all correspondence with NewMar. Ideally provide a photograph of the product label for reference.

4 SCOPE

This manual covers essential information for the installing and commissioning of the NewMar Power System Commander II (CMDRII) and Commander II+ (CMDRII+) where the significant difference between the systems is the number of rectifier shelves and the presence of a DC-DC converter shelf, respectively.

NOTE: System set-up for the controller, power modules and other ancillary devices are provided in separate manuals. Where appropriate these are supplied with the system.

IMPORTANT: this is a generic manual. The Commander II & II+ systems can be configured with a wide range of options. Should this manual not cover any part of the functionality of your system please contact your NewMar representative or sales@poweringthenetwork for further information as required.

5 SYSTEM OVERVIEW

The Commander II range is designed to allow a customized DC power solution with all the benefits of a standard "off the shelf" system.

The system is intended to be a complete power system in a box with no connections needed to be made internally. The system is designed to be extremely simple to install and set up.

All the AC and DC connections are made from the front of the unit. Alarm connections are also accessible from the front by opening the hinged front cover.

By adding smart distribution modules, the system can be customized to suit most requirements whilst maintaining a robust and smart user experience.

NOTE: the system is supplied with the AC and DC earths connected. The standard system output has the DC Common in the positive side of the circuit (+ve earth system).



EM4x Controller Hinged Front Panel

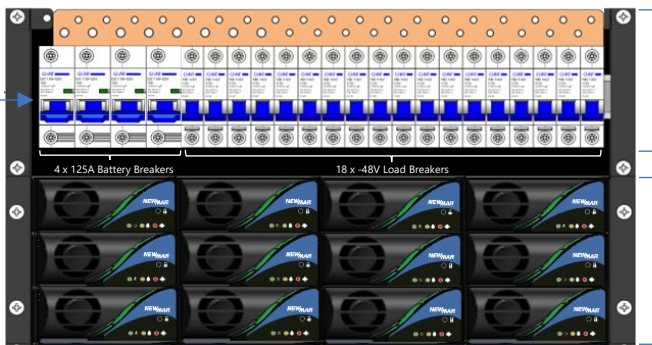

Commander II

- DC Distribution
- 4x 125A Battery MCBs (standard)
 - 18 x -48V Load MCBs (standard)
 - Load & Battery Common Terminals
 - 500A/50mV Battery Shunt
 - 500A LVD
 - AC Input Terminals (at rear)

- Up to 12 x 3kW Rectifiers
- 36kW/720A max

Note: These systems feature multiple configuration options. Consult the factory or your NewMar representative for additional options



EM4x Controller Hinged Front Panel

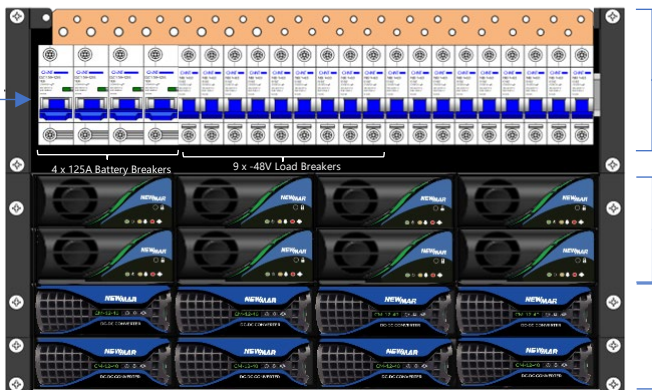

Commander II+

- DC Distribution
- 4x 125A Battery MCBs (standard)
 - 18 x -48V Load MCBs (standard)
 - Load & Battery Common Terminals
 - 500A/50mV Battery Shunt
 - 500A LVD
 - AC Input Terminals (at rear)

- Up to 8 x 3kW Rectifiers
- 24kW/480A max

- Up to 8 x 600W DC to DC Converters (12v or 24V)
- 4.8kW/320A max

5.1 Power System

5.1.1 Standard Features

The base unit is supplied with the following standard options:

- AC Input: Single Phase, 240VAC input
- DC Output: Nominal voltage: 48V DC (contact NewMar for other voltage options)
- EM4x energy manager system controller (fully integrated in the system)

- Battery Low Voltage Disconnect 500A rating
- CTO Configuration:
 - AC input MCB with surge protection device, type 2
 - 4 x DIN style 27mm battery MCBs
 - 18 x DIN style 18mm load MCBs (max 12 when fitted with 4 battery breakers)
 - Low voltage battery disconnect (LVBD) and low voltage load disconnect (LVLD)

5.1.2 Current Capacities

- Commander II system capacity is up to 720A with a maximum of 12x RM3048HE power modules. The Commander II+ system capacity is up to 480A with a maximum of 8x RM3048HE and a maximum of 8 DC-DC converters with 12V or 24V output at 40A and 43A, respectively.

5.1.3 Additional Features

- AC input MCB with surge protection device, type 2
- I/O board
- AC monitoring including voltage, frequency and current
- Fan control
- Battery control monitoring
- Battery fuse fail
- Site monitoring

5.1.4 Physical Dimensions and Weights

Table 1: Commander II & II+ dimensions and weights

Model	Commander II	Commander II+
Depth (Total)	380mm	380mm
Width (Total)	483mm (19" mount)	483mm (19" mount)
Height	267mm (6U)	311mm 7U
Weight without rectifiers	22.7kg	22.7kg
Weight with max. rectifiers	38.3kg	46.7kg

5.2 Energy Manager

5.2.1 EM4x-01 Interface

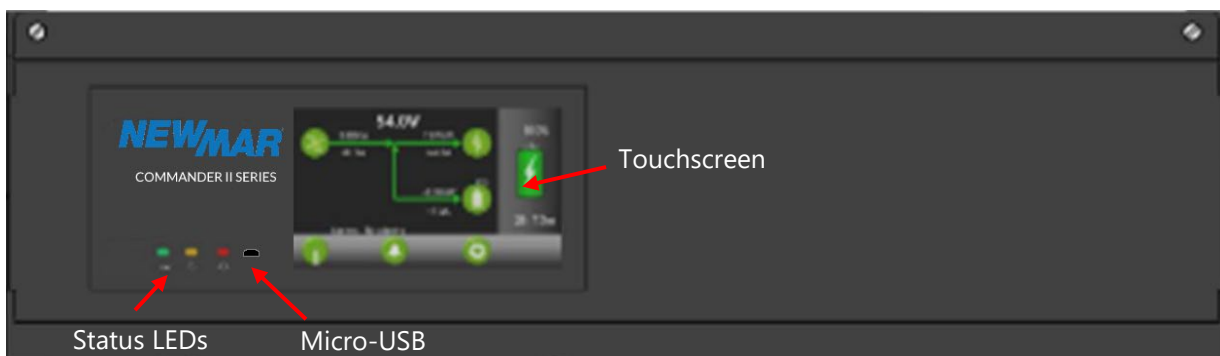

Figure 2: EM4x-01 Front Panel Interface

IMPORTANT: all system and module documentation can be accessed via the micro-USB port on the front panel of the energy manager.

5.2.2 Alarms and Status Indicators

- Status LEDs:
 - Red LED Urgent alarm state.
 - Orange LED Non-Urgent alarm
 - Green LED DC power is connected to the unit; Energy Manager is functioning

NOTE: The LED mapping can be user modified.

- The energy manager is fitted with an audible buzzer which can be configured to alert to any alarm depending on the alarm mapping.

NOTE: To disable the buzzer when active, tap the screen.

- Micro-USB Connector: can independently power the EM4x and provides access to the Web UI

5.2.3 Energy Manager Touchscreen

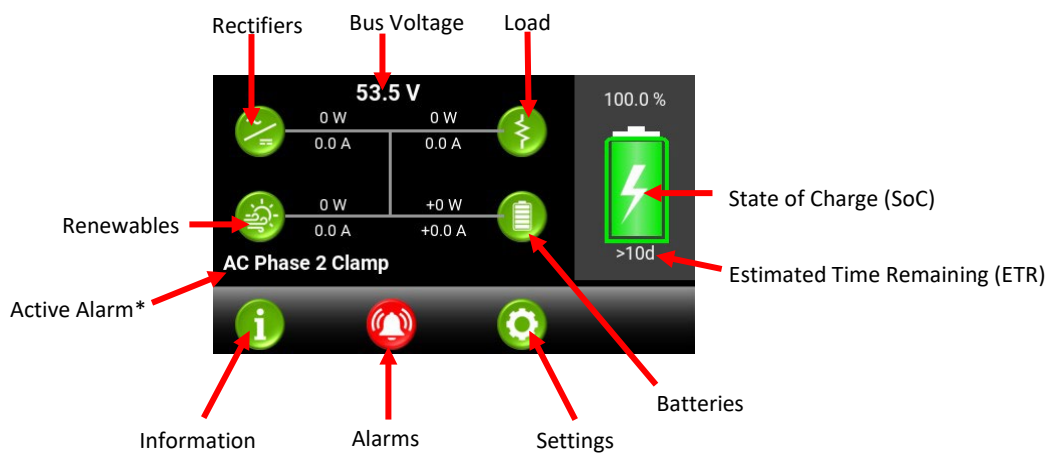

Figure 3: Energy Manager Touchscreen

*NOTE: when there are multiple alarms raised the Active Alarm display cycles through the list. The complete list can be viewed by tapping Alarms.

Tap the touchscreen to navigate through the menus.

NOTE: the EM4x-01 has the option to PIN lock function change through the front screen interface. See the EM4x manual for details.

5.2.4 EM4x Features

The EM4x microcontroller-based DC system energy manager provides the control and monitoring functions for all NewMar Energy's power systems. With an appropriate communications connection third party lithium battery can also be managed.

The EM4x monitors all power system conditions including DC voltage, rectifier current, battery current, battery temperature, distribution failure and battery pack status. It has an in-built web-based configurator allowing setup of system parameters, monitoring, updating and download of logs using a web browser as well as a front panel interface through which key parameters are also configurable. Visual notification of alarm conditions is given by LEDs and a display mounted on the front of the EM4x, with remote notification being enabled by relay contacts, RS232 or TCP/IP (using SNMP).

The EM4x utilizes a USB communications port which allows for local monitoring of system operations as well as pre-commission and power down configuration of the Web UI.

The EM4x also incorporates the following features:

- Support for NewMar's battery modules with optimized battery backup functions
- Support for third-party external batteries, both lead-acid and lithium based
- Support for AC-DC rectifiers (24V and 48V Outputs)
- Support for DC-DC converters (12V, 24V and 48V Outputs)

- Control of up to two low voltage disconnects (magnetically latched contactors) per I/O board*
- Network connectivity (web access)
- System voltage metering for primary system DC supply. (e.g., 48V primary DC output)
- Load, battery and rectifier current metering and alarms
- Active rectifier and converter current share
- Automatic system voltage control
- Effectively unlimited alarm thresholds as standard, for use with multiple DC outputs
- Advanced monitoring, display and logging of battery packs, and system performance data
- Advanced hybrid site control and monitoring with patented anti-stall feature for generators.
- Phase balance controls for multi-phase and single-phase AC input management
- Sophisticated programmable logic control
- For lead-acid external batteries -
 - Battery and room temperature metering and alarms (when fitted with optional temperature sensors)
 - Optional complete or battery mid-point monitoring (when fitted with optional battery monitor cards)
 - Temperature compensation of float voltage (when fitted with optional temperature sensors)
 - Manual equalize charging to prolong the life of the batteries
 - Periodic equalize charging to prolong the life of the batteries
 - Fast charging after battery discharge
 - Battery capacity remaining indication
 - Battery testing facility
 - Battery current limit
- Six user defined General Purpose Inputs (“GPIPs”) which can be software configured as either digital or analogue inputs* (up to 10 may be made available under special circumstances)
- Six relay outputs*
- I/O Expansion card capability*
- Expanded serial and CAN communications – up to 5 I/O boards can be connected to a single EM4x *
 Note: the addition of an I/O Expansion card to the EM4x allows for analogue inputs and increases the number of digital inputs and relay outputs available. The controller allows for these new inputs/outputs to be logically combined allowing a degree of control of peripheral functions. E.g., a temperature triggered room fan or humidity detection.

5.3 Rectifier Modules

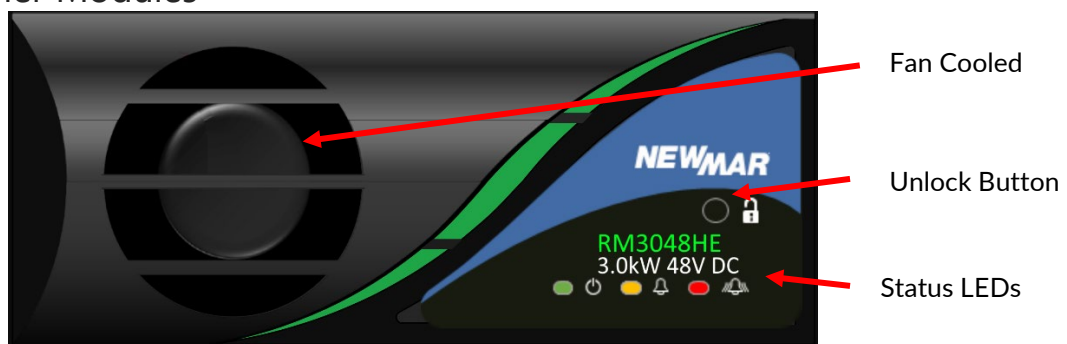

Figure 4: RM3048HE Rectifier

The RM3048HE is a telecommunications grade rectifier with the following features:

- High efficiency
- Hot pluggable
- Forced air cooled
- Thermally protected

- Power factor corrected
- Wide input AC voltage
- Constant power output limit
- Input/Output voltage and current protected
- Active load sharing
- Serial alarm and control interface
- Microprocessor controlled

There are 3 LED indicators on the front panel which indicate the operational state of the rectifier:

Red LED	Urgent alarm state.
Yellow LED	Non-Urgent alarm.
Green LED	DC power is connected to the unit. This LED flashes during power save mode.

6 INSTALLATION



WARNING All upstream AC, Load and Battery breakers must be switched OFF prior to installation. The system must be completely de-powered.

All circuit breakers in a NewMar power system must be in their OFF position prior to installation.



WARNING Use extreme care when fitting batteries & their connections. Remove all conductive materials from yourself such as watches, jewelry and rings prior to commencing the installation. DO NOT short terminals when working on them.



WARNING Use extreme care when fitting solar panel connections. DO NOT short terminals when working on them.



CAUTION Avoid resting cables on sharp edges (cold-creep)



The energy manager contains static sensitive components that require careful handling and proper precautions to be taken. A grounding strap should be worn.

6.1 Required Tools

Insulated M6 or 1/4", M8 or 5/16" pozi Screwdriver, insulated 0.6mm x 2.5mm diameter flat head screwdriver, Insulated M10 or 3/8" bolt wrench/ratchet set and as required depending on set up available.

6.2 Suitable Racks

Recommended rack size is 19" and minimum 600mm deep.

6.3 Unpacking

Upon unpacking, check that the unit is not damaged, and that you have the required number of modules and blank panels (if and as appropriate for your system).

NOTE: Do not fit rectifier modules until the Commander power system has been installed into the rack.

6.4 Installing the Commander System

STEP 1: Remove the Drip cover from the system by removing the 3 thumbscrews. Retain for reuse.

STEP 2: Mount the system in the cabinet or rack as appropriate.

STEP 2: Connect the AC supply.

Terminate the cables to the input circuit breakers and the terminal blocks for Earth and phase to phase (or L1 to L2) (see AC wiring options for Commander II series).

NOTE: the AC terminals accept up to 1/0 AWG/55mm² cables.

NOTE: the AC earth terminal is connected directly to the system chassis.

NOTE: AC and DC EARTHING - This system has a built-in AC to DC earth connection. No extra AC to DC earth link cable is required. However, an additional grounding point has been provided to ensure the unit meets any additional requirements. Removing this link will void the warranty. Please check with NewMar should this link be required to be removed.



Figure 5 Top Cover



Figure 6: AC Termination

STEP 4: Connect the Load.

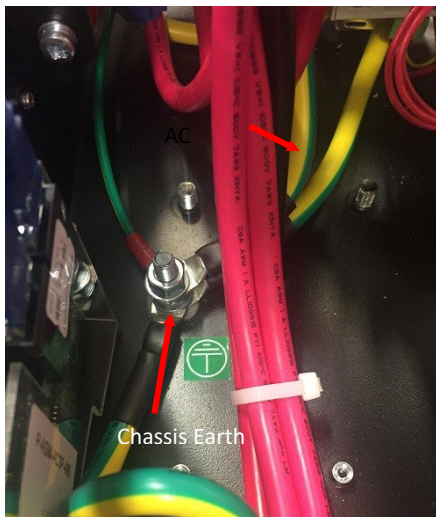

Figure 7: AC Earth Termination



Figure 7A: External Earth Termination

Load Common (+ve): all load common connections are made to the connectors placed behind the circuit breakers. 2 sizes of common terminals are available, up to 4AWG/25mm² and 2 AWG/35mm².

NOTE: cables smaller than 6mm² (10 AWG) should be terminated to the 4AWG/25mm² connectors to make sure of adequate clamping force.

Load Live (-ve): Load Live cables are connected directly to the terminals at the top of the circuit breakers. Load breaker terminals are sized to accept cables up to 4AWG/25mm².

Load distributions that include a secondary load LVD (LLVD) are split into 2 sections to allow prioritization of the connected loads. Non-priority loads are removed from circuit prior to the primary battery LVD operation to extend the time of operation of the priority loads. Load distributions in systems without the secondary LLVD are all removed from circuit together at the battery LVD disconnect point.

Please refer to the specification of the system to determine which breakers are priority and non-priority loads (if optional).

NOTE: make sure all incoming cables have adequate strain relief.

STEP 5: Connect the Batteries

Battery Common (+ve): All Battery Common connections are made to the busbar located placed behind the Circuit breakers. Accepts cables up to 1/0 AWG/55mm².

Battery Live (-ve): Battery Live cables are connected directly to the terminals at the top of the circuit breakers. Battery breaker terminals are sized to accept cables up to 1/0 AWG/55mm².

NOTE: make sure all incoming cables have adequate strain relief.



Figure 8 Connecting the load

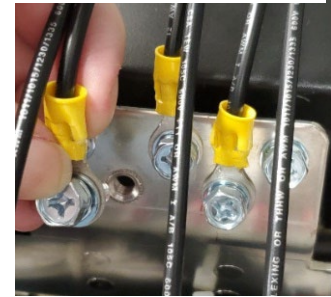

Figure 8A Connecting the load



Figure 9 Connecting the battery

STEP 6: Secure the cables using the Cable Management System

Attached to the top of the unit is the cable management system. The system will accommodate cables up to 2 AWG/35mm². Start by inserting the cable tiedown into the slotted aluminum rail. Rotate clockwise to lock the cable tiedown into place. For cables up to 6AWG/16mm², place the cables across the cable tiedown and secure with a cable tie. For cables up to 2 AWG/35mm², place the cables on either side of the cable tiedown and secure with a cable tie.

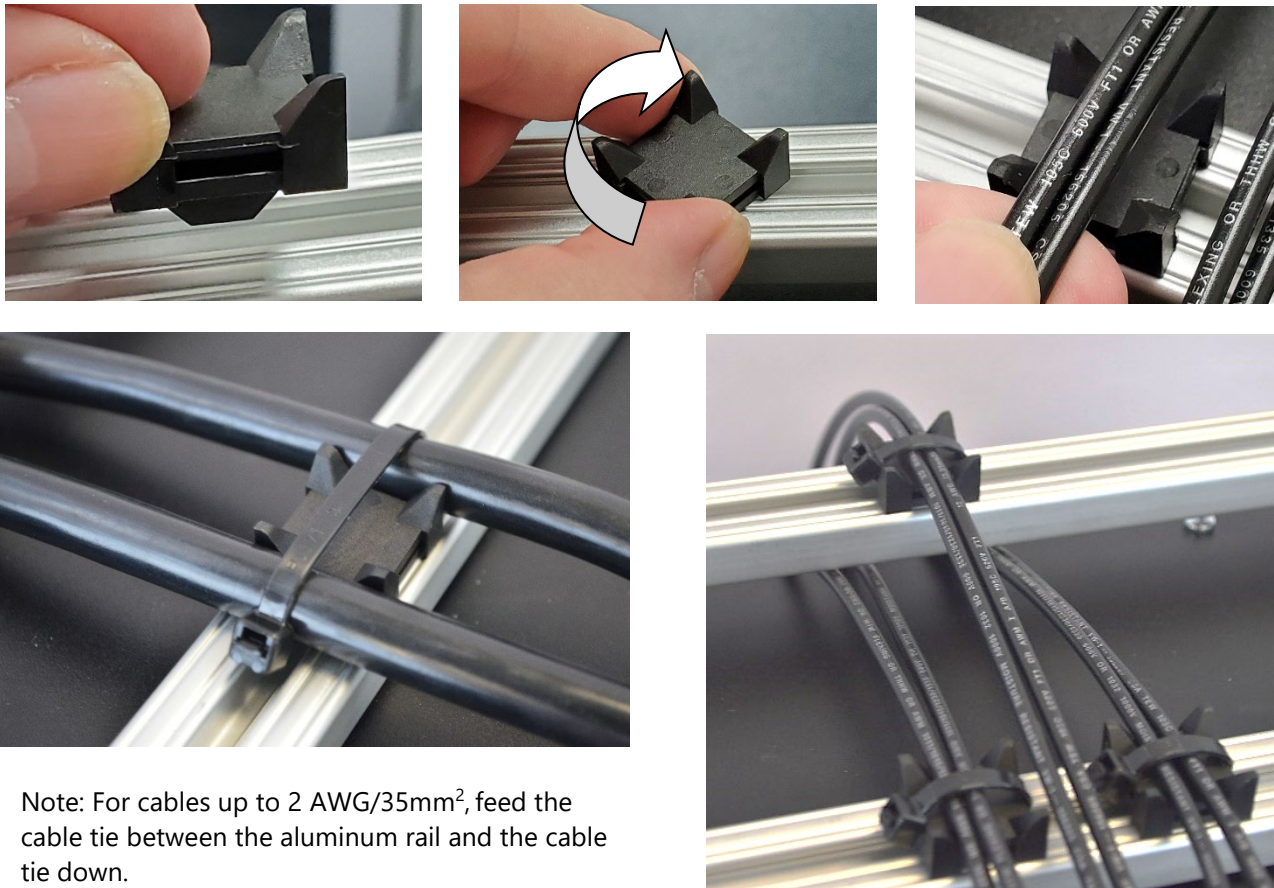

Note: For cables up to 2 AWG/35mm², feed the cable tie between the aluminum rail and the cable tie down.

Note: Alternate and stagger the cable tie downs to maximize the available space.

Figure 10 Cable Management

STEP 7: Affix the Battery Temperature Sensor

Uncoil and affix the battery temperature sensor in the center of the middle battery string.

NOTE: The purpose of battery temperature sensor is to monitor the ambient temperature of the batteries over long periods of time and adjust the rectifier output (float) voltage accordingly.

NOTE: Refer to the specifications supplied by the battery vendor for battery operational temperature requirements.

STEP 8: Affix the Ambient Temperature Sensor

Uncoil and affix the ambient temperature sensor in a position that will give an indication of average cabinet/room temperature.

NOTE: refer to the EM4x energy manager, RM3048HE Rectifier

STEP 9: Terminate External I/O Connections

Terminate external I/O connections if any to the Energy manager. Refer to the EM4X Relay output and digital input sections for mappings in the EM4x Manual. The Monitor layout is as shown in Figure 12.

NOTE: The inputs are normally activated by connecting system positive (usually system common) to the input.

NOTE: Route and secure Alarm Extension Loom away from AC and DC cables

NOTE: For full EM4x functionality and operation information, refer to the EM4x Manual.

STEP 10: Secure the Drip Cover

Secure the drip cover to the top of the unit with the thumbscrews

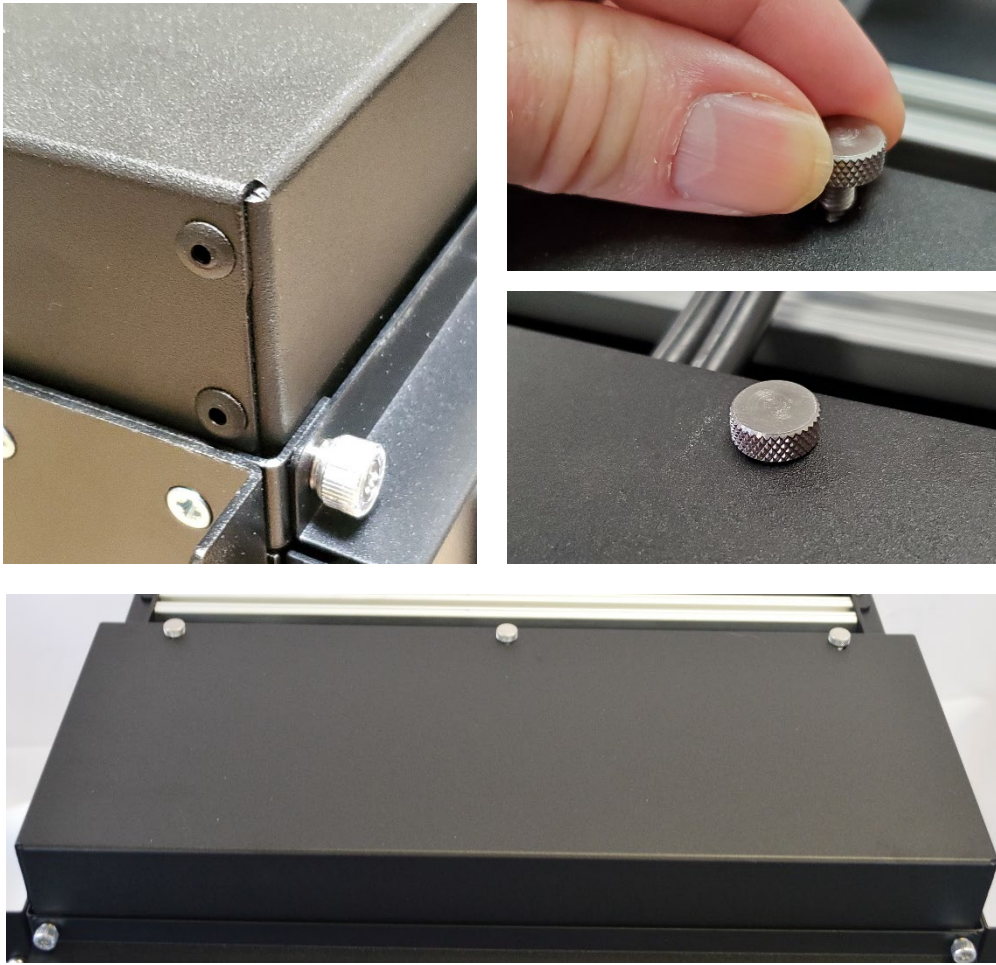

Figure 11 Securing the drip cover

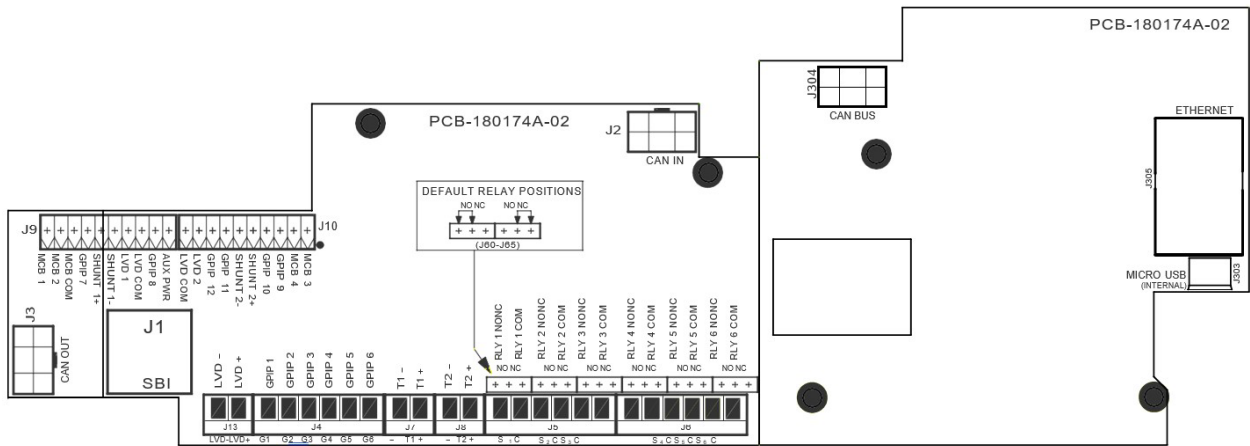

Figure 12: Controller Layout

6.5 Rectifier Module Insertion and Removal



Figure 13: RM3048HE Front Panel

Rectifier modules are shipped separately. They must be plugged in to the system prior to power-up. The rectifier modules are designed for “hot plug-and-play”. It is safe to insert and remove modules at any time, even when the system is loaded. The rectifier modules are self-addressing, meaning that no setup is required for the EM4x controller to determine rectifier addressing.

IMPORTANT: if a rectifier is removed from the system and then plugged into another rectifier slot, you must wait for the red LED to extinguish (this clears the address setting in the EPROM).

When inserting the module, ensure that it is pressed hard into the system. The locking button should click. See Figure 14.

To remove the module, press the locking button while pulling on the “handle” that is integrated into the front panel. See Figure 15. Check that any blank rectifier slots have the rectifier blank panel inserted to prevent air back-flow.



Figure 14: Inserting a Rectifier

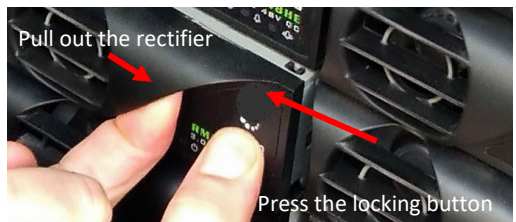

Figure 15: Removing a Rectifier

6.6 Ventilation

The performance of the rectifier or other power modules can be limited if the ventilation is restricted. The rectifier is cooled by drawing air into the front of the unit with a single fan. This air passes through the rectifier cooling the electronics and exiting the rectifier at the rear. For efficient airflow:

- Check the air at the front of the rack is at ambient temperature and not being heated by other equipment.
- That the rectifier shelf has at least 3"/75mm clear horizontal space behind it. This space must be clear of cables and any other components that may restrict air movement.
NOTE: if multiple rectifier shelves are installed then there should be at least 3"/75mm clear horizontal space per shelf.
- Check the free space in the rack continues vertically to the exhaust point at the top of the rack, without impediment.
- Check the hot exhaust air does not re-circulate to the front of the rack as this will be drawn into the rectifiers again, in effect raising the apparent ambient temperature.
- Check the operating environment is low dust and fiber.



Pay particular attention to the quality of rectifier air intake. Insects, sand, and other extraneous matter ingress seriously impacts the performance of the rectifiers.

7 ENERGY MANAGER CONNECTIVITY AND THE WEB UI

The energy manager is configured via a web browser-based user interface (Web UI).

There are two methods to access the Web UI:

1. Ethernet connection from the J305 ethernet connector
2. Front panel micro-USB local connection

7.1 Access Levels

There are 3 access levels for the Energy Manager Web UI:

- enaguest* : can only view status of system
- enabasic* : reduced privilege, can view settings and system status
- enaadvanced* : this user has normal full control access of the system

The default password for all levels = ena123

7.2 Ethernet Port Connection



The energy manager contains static sensitive components that require careful handling and proper precautions to be taken – an electrostatic discharge protection device must be worn.

Figure 16: Energy Manager Ethernet Port

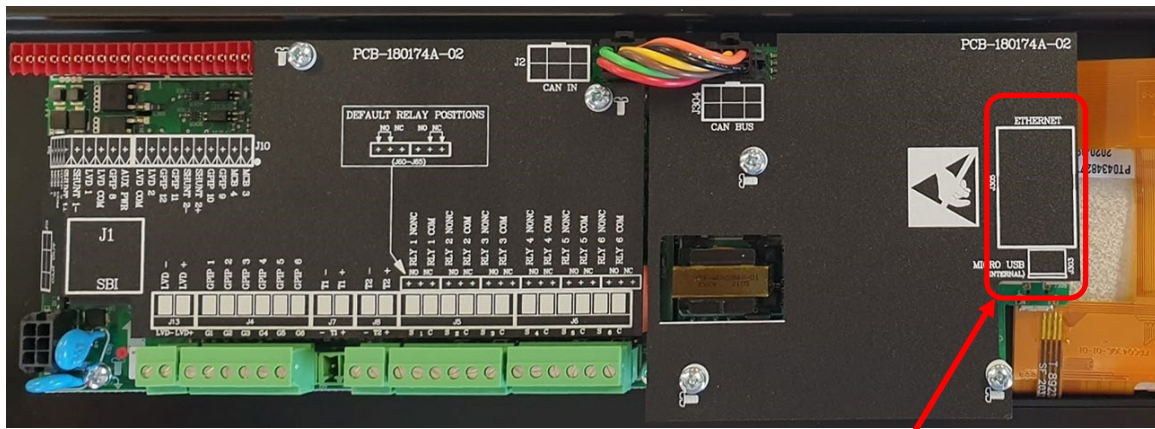

Ethernet Port

1. Connect the communicating device to the J305 Ethernet port inside the energy manager.
 2. Open an internet browser such as Edge, Chrome, Firefox or similar on the device.
 3. Enter the Ethernet default IP address into the internet browser.
- NOTE: the energy manager IP address can be located from the front panel LCD menu under: Settings>Networking>Ethernet.
4. The energy manager log in page appears.
 5. Enter the user name and password. See [7.1 Access Levels](#).

7.3 USB Connection

Figure 17: 3U EM4x-01 Front Panel micro-USB



1. Connect the communicating device to the micro-USB port on the front of the energy manager. See Figure 17.
A driver installation prompt appears.
- | | | | | |
|--|--|--------------------|-----------------------|----------|
| | Enatel Linux Products USB Installer (32-bit) | 20/05/2018 9:46 PM | Windows Installer ... | 1,188 KB |
| | Enatel Linux Products USB Installer (64-bit) | 20/05/2018 9:46 PM | Windows Installer ... | 1,556 KB |
2. Double-click the appropriate USB driver (32bit or 64 bit).
 3. Follow the installation wizard instructions to install the driver.
 4. Open an internet browser such as Edge, Chrome, Firefox or similar.
 5. Enter the USB default IP address into the internet browser: 172.31.250.1
 6. The energy manager log in page appears.
 6. Enter the username and password. See [7.1 Access Levels](#).

Note: USB connection to the energy manager is possible without AC, battery or other external power supply. The EM4x operates drawing power through the USB port. However, USB supply does not power the IO Board.

In this scenario there is a set of alarms that display depending on the system configuration relating to the nonoperation of the IO board.

For example:

Relay Logic Error	Input and Relay...
IOBoard 1 Missing	IO Board
Battery Temperature Faulty	Battery
Ambient Temperature Low	General Alarms

For information on the use of the energy manager Web UI please refer to the Energy Manager Installation and Operation Manual.

7.4 Energy manager & IO PCB Alarm Output Configuration

For full EM4x functionality and operation information, refer to the EM4x Installation and Operation Manual.

7.4.1 EM4x LED Alarm Mappings

Refer to the Alarm Configuration>Alarm Configuration page of the Web UI to see the priority setting of each alarm.

Refer to the Relay/Output page Configure Relay section of the Web UI to understand the how the Alarm Configuration is mapped to the EM4x LEDs.

7.4.1.1 EM4x Red LED Urgent Alarm Mapping

The image shows two parts of the Web UI. On the left is a list of alarm mappings to LEDs:

- Yellow LED - non Urgent alarm (Monitor Yellow LED)
- Red LED - Urgent alarm (Monitor Red LED)
- Rly 2 Rectifier Urgent (IO Board 1 Relay 2)
- Rly 3 Ambient Temp High (IO Board 1 Relay 3)
- Rly 4 Battery Discharge

On the right is the 'Configure Relay' page. It has the following fields:

- Relay Name: Red LED - Urgent alarm
- Relay/Output: Monitor Red LED
- Logic Mode: Simple (selected)

At the bottom, there is a dropdown menu with '(Any Critical Alarm)' selected, and a red box highlights this dropdown and a '+' button next to it.

(For reference only. Actual system alarm mapping may vary)

7.4.1.2 EM4x Yellow LED non-Urgent Alarm Mapping

Relay 3	Critical alarms	Red LED
Relay 4	Spare	
Relay 5	Spare	
Relay 6	Spare	
Buzzer		Red LED

7.4.3 EM4x Main PCB Digital Input Alarm Mappings

General purpose inputs allow the Commander II & II+ system to monitor any external equipment that includes relay or auxiliary outputs. The GPIB inputs are activated by connecting the system positive (common) to the input terminal (configuration setup in the EM4x can allow activation by connecting to system live).

General purpose inputs can also be configured as analogue inputs for purposes such as battery midpoint monitoring and voltage monitoring.

These inputs may be assigned to contribute to alarm states within the monitor. The state mapping is defined in the configuration file. Alarm mapping should be completed using the EM4x software. Please refer to the EM4x manual for detailed information.

The inputs are normally activated by connecting system positive (usually system common) to the input.

7.4.4 Circuit Breaker Fail Monitoring

Comment: Main circuit breakers (MCBs) are monitored electronically via a diode to a digital input on the EM4x. The digital input will trigger an alarm when it is pulled to the system common (positive) rail. The Breaker Fail alarm will only operate if a load is connected to the output to provide a return circuit for the sense wire. Therefore, for breakers that do not have a load connected, the breaker can remain in an OFF position without causing a false alarm.

The battery circuit-breakers, however, use voltage sense to detect tripping or whether they are turned off. This is because when a battery breaker is tripped, there may be very little voltage difference across the breaker, making electronic fail detection problematic. Hence, if no battery is connected, the breaker must be ON to clear the Battery Breaker Fail alarm.

8 LVD OPERATION

The primary Low Voltage Disconnect contactor is located in the battery side of the DC distribution. A secondary Load Low Voltage Disconnect can be optionally included in a section of the load side of the DC distribution.

The LVD contactor is a bi-stable, magnetically latching contactor. This means that failure of power or removal of the EM4x from a live system will not cause the contactor to change state. Periodic pulsing of the LVD control signal allows the monitor to ensure the contactor remains in the correct state. The contactor is monitored by the EM4x to allow an alarm to be generated when the contactor is open.

The EM4x energy manager unit is powered from both the rectifier side of the LVD contactor and direct from the battery source. Following an extended AC outage and the low output voltage threshold being reached, the primary LVD disconnects the battery from the system live bus and the EM4x will lose voltage sense (as voltage sense is measuring system live bus voltage) yet still maintains operation for system monitoring. The LVD contactor will not re-engage until rectifier input supply is restored (i.e., until the DC bus voltage is re-established). LVD adjustments/settings are all made in the supervisory module.

9 MAINTENANCE

As NewMar power systems are state of the art electronic systems, little routine maintenance is required.

9.1 System

- During normal operation the cable entries to the MCBs may loosen over time due to movement in the cable strands. To avoid damage to the MCB's and cable entries due to heat build-up and arching, it is recommended that the retaining torque is periodically checked at least annually.
- MCB's should be maintained at a torque of 2Nm.
- All other connections should also be checked at this time.

9.2 EM4x Controller

- The controller can give a good indication of the condition of the system. Alarm logs can show issues with the system and rectifiers and should be regularly checked.
- As a minimum, check that the float voltage and load current is as expected.
- If the batteries are fully charged, check the battery current is zero or near to zero amps, and check that the amp-hours remaining is 100%.

9.3 Rectifiers and Converters

- During normal operation some dust will build-up on the front of the rectifiers. This should be kept to a minimum by regularly wiping the rectifiers to avoid accumulation within the rectifiers and blocking the airflow to the units. The positioning of the system and surroundings will determine the regularity of this requirement.
- In extremely dusty positions it is recommended that the units are removed and cleaned with compressed air to prevent airflow blockages.
- Check the air flow front and back to the rectifiers is unimpeded by cables or otherwise.
- Check nothing has entered the rectifiers such as insects or geckos.

9.4 Batteries

- Battery maintenance depends on the individual manufacturer's specification, please contact the battery supplier for recommendations.
- Periodic discharge tests may be beneficial to ensure reliable system operation and may be recommended by the battery manufacturer.



CAUTION The user must be aware of the consequences of battery State of Health (SoH) with regards their specific load requirements and implement their own policy regards the end of life of the batteries.

9.5 Ventilation Maintenance

Check that there has been no change in the required airflow space or environment that impacts the ventilation. Refer to [6.6 Ventilation](#) for the required details.

10 TROUBLE-SHOOTING AND SERVICING

If the red  LED is alight:

- Unplug the rectifier and re-engage.
- Check AC power to the rectifier.
- Check for rectifier alarms in the monitor Urgent Alarm list.
- If symptoms persist, contact a service agent.

If the yellow  LED is alight:

- Check the monitor Non-Urgent Alarm list.

10.1 Servicing



DANGER Do not operate the rectifiers, converters or other power modules if the covers are damaged or removed in any way.



WARNING The rectifiers, converters or other power modules contain voltages that may be lethal even after the input supply has been removed.



WARNING The rectifiers, converters or other power modules contain components at high temperature that may burn if touched

To isolate a rectifier or converter from the power supply, unplug it from the shelf. The power modules contain no user serviceable components. Do not disassemble the modules. If a power module has an operational fault or is damaged in any way, an authorized service center should service it immediately.

11 ESSENTIAL SYSTEM SET-UP PARAMETERS

The following steps are system settings that must be checked at the time of commissioning for each system installed. You can print this section and fill it out for each site commissioned.

NOTE: these steps are battery chemistry dependent. Follow the appropriate section.

11.1 Systems with Lead Acid Batteries

Failure to correctly follow the items below may cause incorrect system functionality and in some cases ruin your battery (without the ability to claim battery replacement under warranty).

NOTE: Any values shown below are indicative only. If the values in your system differ from those shown here, write in the values relevant to your system.

Refer to the EM4x energy manager manual for more details.

11.1.1 Check the Battery Type

The system MUST be configured to the correct battery type.

EM4x Web UI page [Battery > Battery Settings](#)

Battery Type

Lead Acid Basic Li Energypak Modular Li ↻

Done

11.1.2 Check/Set Float Voltage

Consult battery manufacturer's data for proper setting.

The Float voltage is for 25°C reference temperature in NewMar systems.

EM4x Web UI page: [Control](#)

Example:

Float Voltage

54

V



Site Setting:

Float Voltage

Done

11.1.3 Set Battery Temperature Compensation

Toggle temperature compensation On.

EM4x Web UI page: [Battery>Battery Settings](#)

Rectifier Compensation

You must consult the battery manufacturer's data to obtain the correct Slope setting. Note that in many Hybrid applications where the battery is constantly being cycled, having temperature compensation enabled may not be necessary as the voltage on the battery is constantly changing anyway.

EM4x Web UI page: [Battery>Battery Settings](#)

Example:

Maximum Temperature	<input type="text" value="55"/>	°C	↺	✓
Minimum Temperature	<input type="text" value="0"/>	°C	↺	✓
Number Of Cells	<input type="text" value="24"/>	cells	↺	✓
Temperature Slope	<input type="text" value="-3"/>	mV/°C/cell	↺	✓

Site Settings:

Maximum Temperature	<input type="text" value=""/>	°C	↺	✓
Minimum Temperature	<input type="text" value="0"/>	°C	↺	✓
Number Of Cells	<input type="text" value=""/>	cells	↺	✓
Temperature Slope	<input type="text" value=""/>	mV/°C/cell	↺	✓

Done

If you choose not to enable Temperature Compensation, then set the Rectifier Float Voltage to that required by the battery manufacturer for the average long-term temperature you anticipate your system to operate at.

11.1.4 Set Battery Capacity

Consult the battery manufacturer's data for correct battery capacity settings.

For the EM4x to set the correct Battery Current Limit current, it is essential that this is filled out correctly.

These figures are also used for estimating the Battery Time Remaining during a discharge.

For Telecom applications, the 10-hour rate is usually the name-plate rating of the battery. However, once again, check the battery manufacturer's data sheets as some manufacturers state the 20-hour rate (which is usually a little more "optimistic").

The second rate is required specifically for the time-remaining algorithm. A 4-hour rate is usually a good one to use. This information is available from the battery manufacturer's data sheet.

The Battery SoC adjust can be used at the time of installation (or for testing purposes) in case the installed battery is not initially fully charged. If you think the battery is only 80% charged, then simply enter that value. The value displayed here will correct itself once the battery has been on charge for some time or gone through a few charge/discharge cycles.

Battery Recharge Efficiency considers the ohmic and any other losses in the battery charge/discharge cycle.

The effect is that more energy (Ah) needs to be put back into the battery than was taken out. With the efficiency set to 96%, then 4% more Ah is needed to be returned to the battery before the EM4x will register that the battery is at 100% SoC.

The Battery Discharge Threshold is a buffer to prevent false triggering of discharge notification and is usually related to the size of the battery shunt. A larger shunt requires a larger discharge threshold.

EM4x Web UI page: [Charge](#)

Example:

10h Rate Battery Capacity	650	Ah	↺	✓
Secondary Capacity Rate Time	4	h	↺	✓
Secondary Capacity	500	Ah	↺	✓
Battery Recharge Efficiency	96	%	↺	✓
Battery State Of Charge	64.5	%	↺	✓
Battery Discharge Threshold	-3	A	↺	✓

Site Settings:

10h Rate Battery Capacity		Ah	↺	✓
Secondary Capacity Rate Time		h	↺	✓
Secondary Capacity		Ah	↺	✓
Battery Recharge Efficiency		%	↺	✓
Battery State Of Charge		%	↺	✓
Battery Discharge Threshold		A	↺	✓

Done

NOTE:

Both the 10 hour and secondary battery capacity hour rates should be set at the same time. The EM4x compares rates to ensure the battery data is accurate and may not accept the setting if an inaccuracy is detected.

11.1.5 Set Battery Current Limit

Consult battery manufacturer's data for maximum battery recharge current settings.

The Battery Current Limit is set as a percentage of the 10-hour rate entered above.

It is recommended this value is set at the highest rate allowable to ensure the battery is recharged as fast as possible.

In some systems, especially larger systems, this may require limiting further because of the number of rectifiers available, rather than the maximum setting.

EM4x Web UI page: [Battery](#)>[Battery Settings](#)

Enable Battery Current Limit by clicking on the tick icon beside the field.

Battery Charge Current Limit	<input checked="" type="checkbox"/>	Disabled	%	↺	✓
------------------------------	-------------------------------------	----------	---	---	---

Example:

Battery Charge Current Limit	<input checked="" type="checkbox"/>	20	%	↺	✓
------------------------------	-------------------------------------	----	---	---	---

Site Settings:

Battery Charge Current Limit	<input checked="" type="checkbox"/>		%	↺	✓
------------------------------	-------------------------------------	--	---	---	---

Done

For telecom settings, this limit is often set to 10% (or 0.1C10, i.e., a 10A current limit for a 100Ahr battery). This is more typical of a design parameter than the need for the setting to be at this level but a setting higher than this level should be considered to enable the fastest recharge possible without exceeding the battery manufacturer's maximum value.

Ensure sufficient rectifier capacity is available to cover battery recharge and load requirements.

11.1.6 Low Voltage Disconnect Settings

The LVD disconnect set points are usually a customer generated setting.

As the discharge time increases, the higher the end voltage should be set. For a discharge of <1hr, this may be as low as 1.75Vpc (42.0V for a "48V" battery), or for an 8-hour discharge, it may be 1.85Vpc (44.4V for a "48V" battery).

Note that if only one LVD is fitted, LVD2 and LVD3 thresholds are set outside of possible tripping voltages.

This avoids any confusion over which LVD signal is being used by the EM4x energy manager.

EM4x Web UI page: [IO Configuration>IO Boards](#)

Toggle LVD latching On

LVD Latching

On Off

Example:

LVD1 Disconnect	43	V	↺	✓
LVD1 Reconnect	48	V	↻	✓
LVD2 Disconnect	12	V	↺	✓
LVD2 Reconnect	15	V	↻	✓
LVD3 Disconnect	12	V	↺	✓
LVD3 Reconnect	15	V	↻	✓

Site Settings:

LVD1 Disconnect		V	↺	✓
LVD1 Reconnect		V	↻	✓
LVD2 Disconnect		V	↺	✓
LVD2 Reconnect		V	↻	✓
LVD3 Disconnect		V	↺	✓
LVD3 Reconnect		V	↻	✓

Done

11.2 DC System Lead Acid Battery Commissioning Check-List

This section is for a more detailed commissioning process than the Essential Set-up Parameters. It may be printed out separately and filed for record keeping.

DC System Lead Acid Battery Commissioning Check-List

Site Name: _____ Date: _____

Tests Without Batteries Connected	Value	Results
Check Float Voltage	Meter: _____	_____ V ✓ / ✗
Check Load Current	Meter: _____	_____ A ✓ / ✗

Alarms

Voltage thresholds can either be checked using an external power supply, or by adjusting the EM4x float voltage 0.1V above (or below for the low voltage alarms). It is recommended to have the batteries disconnected.

1. Adjust the supply/float voltage to 55.7V & observe the "High Float" alarm.
2. Adjust the supply/float voltage to 57.7V & observe the "High Load" alarm.
3. Adjust the supply/float voltage to 52.7V & observe the "Low Float" alarm.
4. Adjust the supply/float voltage to 46.9V & observe the "Low Load" alarm.

High Load Volts (urgent)	57.6V	_____ V	✓ / ✗
High Float Volts (non-urgent)	55.6V	_____ V	✓ / ✗
Low Float Volts (non-urgent)	52.8V	_____ V	✓ / ✗
Low Load Volts (urgent)	47.0V	_____ V	✓ / ✗

Depending on the test load available, it may be necessary to adjust the High Load Current alarm threshold down to suit. For example, with 40A test load, adjust the Load Current High Setpoint threshold (Web UI page Alarm Configuration>System Alarms) to 35A. Then simply apply the 40A load and observe the alarm change state.

Once the test is complete, be sure to rest the Load Current High Setpoint to its previous value (or check with the customer for the correct value they require).

Load Current High Setpoint	_____ A	✓ / ✗
----------------------------	---------	-------

Temperature alarm tests are performed by heating up (using a heat gun or other source) and cooling down (using an aerosol can of freeze, or a tub of ice) the temperature sensors.

Battery Temperature High (urgent)	_____ °C	✓ / ✗
Battery Temperature Low (non-urgent)	_____ °C	✓ / ✗
Room Temperature High (non-urgent)	_____ °C	✓ / ✗
Room Temperature Low (non-urgent)	_____ °C	✓ / ✗

When an AC Monitoring PCB is not fitted at system level (as in most cases), the AC Fail alarm is generated from the rectifiers. The rectifiers sense if AC is present, and extend an AC fail alarm to the EM4x. Therefore, to test this alarm, simply turn off the rectifier AC breakers. To allow the controller to continue to read alarms there must be DC present on the output of the system.

As this causes the rectifier output to cease, a Rectifier Fail alarm is also generated. To generate the Urgent Rectifier Fail, turn off the required number to make this occur (usually set to 2, but check via the EM4x Web UI for the setting (Control page>Rectifier Urgent Fail Threshold).

AC Fail (urgent)	Urgent	✓ / ✗
Rectifier Fail (non-urgent)	Non-urgent	✓ / ✗
Urgent Rectifier Fail (urgent)	No. Modules:____	✓ / ✗

To check Load MCB fail, connect a load, but with no load turned on. Then switch the breaker to its off position and turn on some load (any amount will do). This will cause the alarm to occur as the load side to the circuit will be taken to system common voltage. Turn off the load, and then return the breaker to its on position.

Load MCB Fail (urgent)

✓ / ✗

Tests with Batteries

- Turn off Battery Breaker/s
- Connect battery/batteries
- Check the correct Battery Capacity (Ahrs) has been entered (EM4x Web UI Battery>Battery Settings). This is the total capacity, so for example 100Ahr strings in parallel, this should be 200.
- Go to EM4x Web UI Battery>Battery Settings>Battery Charge Current Limit. Check Battery Charge Current Limit (BCL) is set to desired level (usually $0.25C_{10}$, (25%)). This means that for a single 100Ahr battery, the BCL will be 25A, or if two 100Ahr batteries are connected in parallel, the BCL will be 50A.
- Connect load (but turn off).
- Check V_f is set to 54.0V. (Web UI Control>Float Voltage)
- Turn on Battery Breaker/s

Check Battery current is positive if charging

✓ / ✗

For systems fitted with Battery Monitoring (BCM) cards:

Go to EM4x Web UI Battery>Battery Status. Check cell voltages are approximately the same, at about 2.25V (or 13.5V for 12V monoblocs).

✓ / ✗

If any are out by a large amount, then check the BCM sense wiring is correct.

Set load to required level (e.g., 30A),

Check operates

✓ / ✗

Initiate a Battery Test.

Click the Start Battery Test button on EM4x Web UI Charge page.

Check Battery Current is negative (discharging). Note the overview data in the header of the Web UI.

✓ / ✗

Check Battery Current

Meter: _____ A

✓ / ✗

After several minutes, or until the battery voltage has dropped below approx. 47V, click the Stop button at the top of the Web UI Charge page.

During this time the Battery Condition Monitor (if fitted) is logging.

Battery Current Limit (BCL)

Check that the battery recharge current is limited to the Battery Current Limit level (usually $0.25C_{10}$, (25%)). See Web UI Battery Settings>Calculated Charge Current Limit for Amp value.

Note: as the BCL is based on fine voltage control of the system bus, the BCL make take one or two minutes to "settle", i.e., you

_____%

may observe a brief excursion of the battery recharge current beyond the BCL setting.

Check Manual Equalise (if configured). Click the Start Manual Equalise button on the Charge page to initiate a battery equalisation. Click the Stop button at the top of the Charge page to end. ✓ / ✗

A Battery MCB Fail alarm is generated from the voltage measured across the battery MCB.

Therefore, to check a Battery MCB Fail alarm, simply open one of the battery MCB's. If batteries are connected to the system at this time, the alarm may take a few moments to activate. Once test is complete, turn breaker back on.

Battery MCB Fail (urgent) ✓ / ✗

Temperature Compensation

Check Temperature Compensation is enabled. ✓ / ✗

Web UI Battery>Battery Settings>Rectifier Compensation>On.

Apply heat or cold to the Battery Temperature Sensor/s. Check the float voltage moves up or down as expected. ✓ / ✗

If actual measurement is required, apply a known heat or cold to the sensor. Allow it to fully come to temperature and record the amount of voltage movement. Temp. _____ °C
Voltage offset: _____ V OK? ✓ / ✗

Check Alarm Relay Contacts

To generate these alarms, refer to the procedures described earlier in the Commissioning Checklist.

Spare relays will not be able to be tested unless an alarm is mapped to them. As these are tested in the factory, it is not essential to test them at time of commissioning.

On main EM4x PCB

Relay 1 (Monitor Fail) ✓ / ✗
(pull out the RJ45 lead connecting the monitor to the system rectifier shelf – this simply de-powers the monitor)

Relay 2 (Summary Non-urgent) ✓ / ✗

Relay 3 (Summary Urgent) ✓ / ✗

Relay 4 (Spare) ✓ / ✗

Relay 5 (Spare) ✓ / ✗

Relay 6 (Spare) ✓ / ✗

NOTE: Prior to leaving the system after it has been commissioned, check all AC, DC and battery circuits are off. If it is required that the system is to be left on (to power load equipment, ensure rectifiers are left in their powered-up state, and batteries are in circuit. This will prevent anyone leaving the batteries only powering the load (in which case the batteries go flat).

11.3 Systems with Lithium Batteries

The term lithium batteries include a wide range of chemistry types. Regardless of the chemistry used the energy manager differentiates lithium (and other non-lead acid batteries) by whether the battery BMS can be communicated to via Modbus RTU or not. These 'smart' batteries are termed modular, where the energy manager is receiving information on alarms and status from the battery internal electronics.

Failure to correctly follow the items below may cause incorrect system functionality and, in some cases, ruin your battery (without the ability to claim battery replacement under warranty).

NOTE: Any values shown below are indicative only. If the values in your system differ from those shown here, write in the values relevant to your system.

Refer to the EM4x energy manager manual for more details.

11.3.1 Check the Battery Type

The system MUST be configured to the correct battery type.

EM4x Web UI page: [Battery>Battery Settings](#)



Battery Type

Lead Acid Basic Li Energypak **Modular Li** ↻

Done

11.3.2 Modular Smart Lithium Battery Selection

If the system is connected via Modbus RTU to a battery BMS check the correct specific battery is selected from the Product drop down list and mapped to the correct address. EM4x Web UI page: [IO Configuration>Modbus Master>Device Map](#)



1 Address SLB48 Product

Done

11.3.3 Check/Set Float Voltage

Consult the battery manufacturer's data for the proper setting. Note that the float voltage directly impacts the state of health of batteries after multiple cycles. The consequences of the float voltage setting must be understood.

The Float voltage is for 25°C reference temperature in NewMar systems.

EM4x Web UI page: [Control](#) Example:



Float Voltage 54 V ↻ ✓

Site Setting:



Float Voltage

Done

Appendix I RECTIFIER FUSE AND FRONT PANEL BEHAVIOUR

I.A Rectifier Input Fuse Characteristics

The NewMar RM3048HE rectifier uses two Conquer UDA-A 025 fuses in its input, one on each phase/line of the AC input.

NOTE: The curves are for average value, for reference only.

Figure 19: Rectifier Input Fuse Tripping Curves

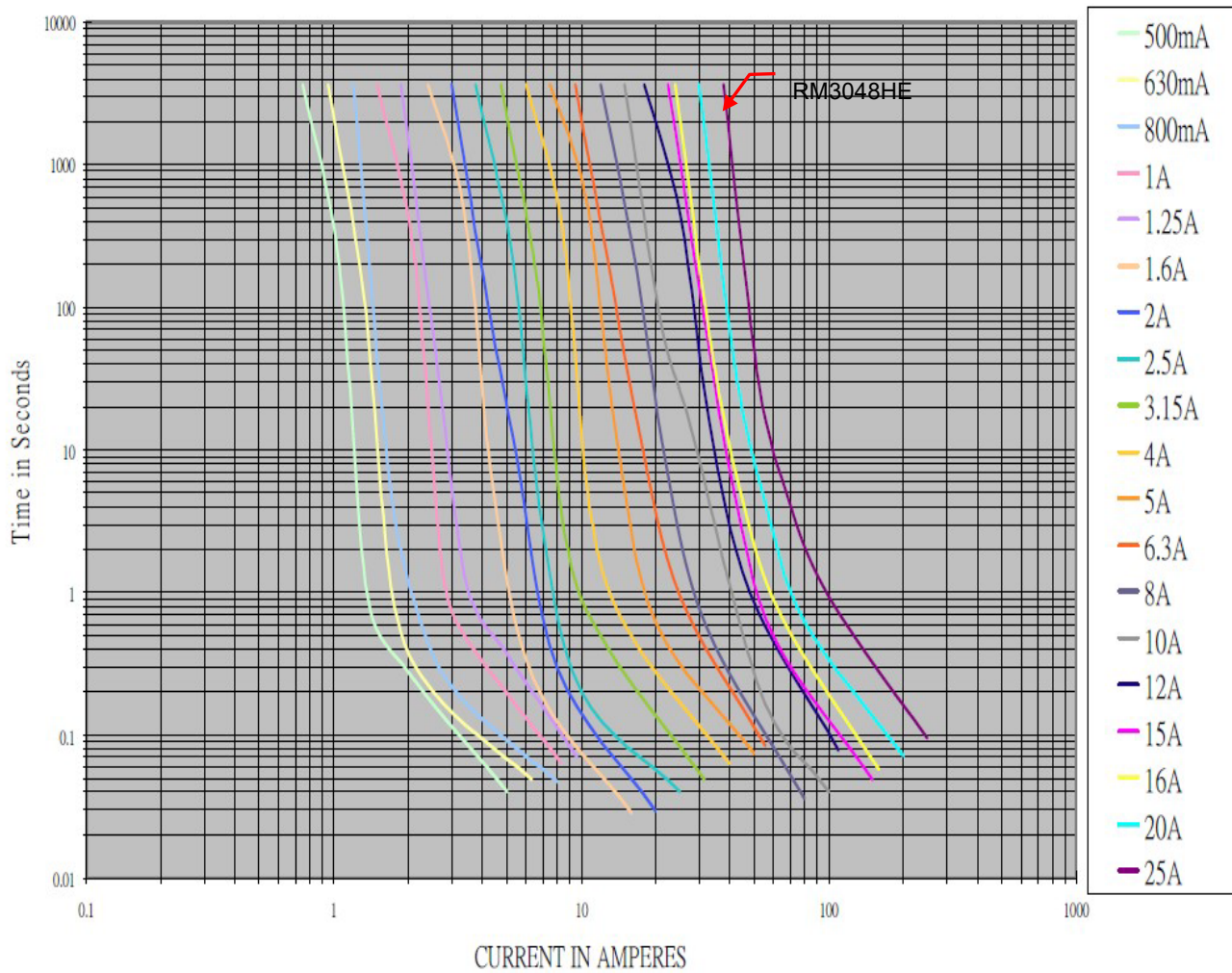

I.B RM3048HE Front Panel Indications

There are three LED indicators on the front panel to indicate the operational state of the rectifier.

 This green LED indicates that input power is connected to the unit and that the primary stages of the rectifier are operating.

 This yellow LED indicates a non-urgent alarm/notification state within the rectifier.

This could be caused by the following:

- rectifier in output power/current limit
- rectifier over temperature
- fan failed
- rectifier soft starting

 This red LED indicates an urgent alarm state within the rectifier.

This could be caused by the following:

- rectifier failed
- the AC input voltage is outside the operating range.
- rectifier shut down due to output over-voltage or over-temperature.

I.C C3C-12-40-48 or C3C-24-25 Converter Front Panel Indicators

- Ⓢ There are 3 LED indicators on the front panel indicate the operational state of the converter.
- 🔔 The green LED indicates that input power is connected to the unit and that the primary stages of the converter are operating.
- 🔔 The yellow LED indicates a non-urgent alarm state within the converter.
- This could be caused by the following:
- Converter in output power/current limit
 - Converter over temperature
 - Fan failed
 - Converter soft starting
- 🔔 The red LED indicates an urgent alarm state within the converter.
- This could be caused by the following:
- Converter failed
 - The DC input voltage is outside the operating range
 - Converter shut down due to output over-voltage or over-temperature

Appendix II AC INPUT TRANSIENT PROTECTION

Information to assist the installer for AC input protection is detailed in this section.

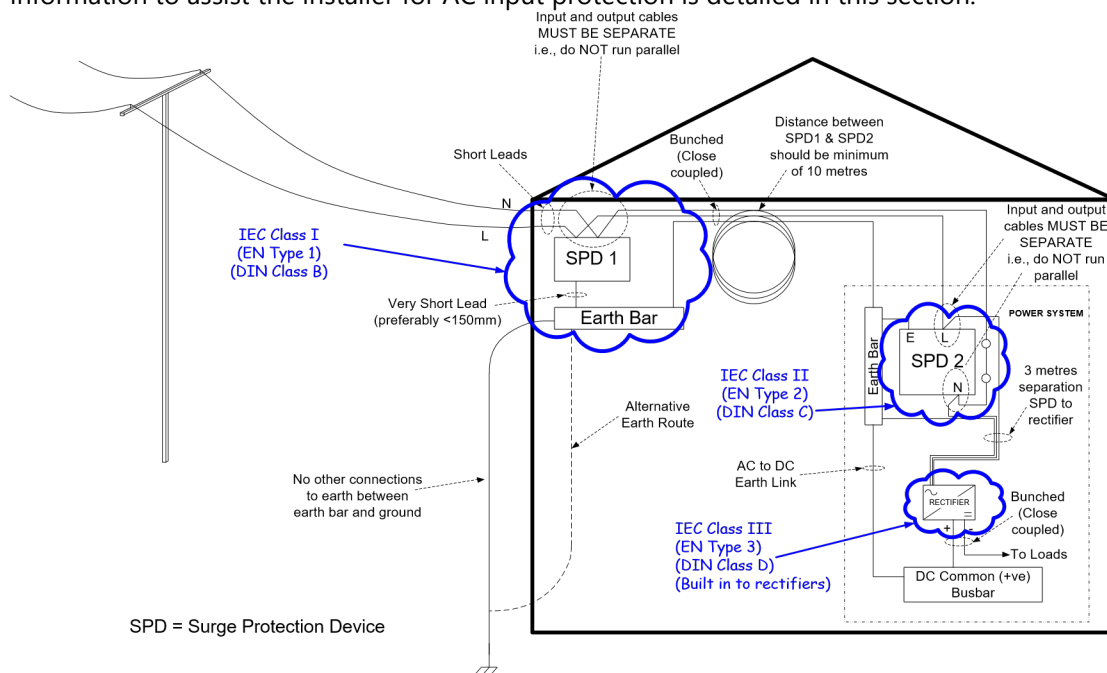

Illustration A: Surge Protection Installation

Illustration A shows the surge protection installation principles, utilizing the 3 stage protection zone concept. The Type 1 (SPD1) surge arrester, fitted in the installation's main incoming electrical switchboard, is capable of diverting the energy of a direct lightning strike. This is the first stage of the electrical network's protection. It is important that upstream Type 1 protection is provided on site. Although the actual surge capability of the device used can vary depending on the severity of lightning in any particular installation, the typical maximum discharge current of a Type 1 surge suppressor will be in the order of 50kA to 100kA (10/350 μ s impulse). The 10/350 μ s current wave as shown below is the standardized current waveform which passes through equipment when subjected to an overvoltage due to a direct lightning strike.

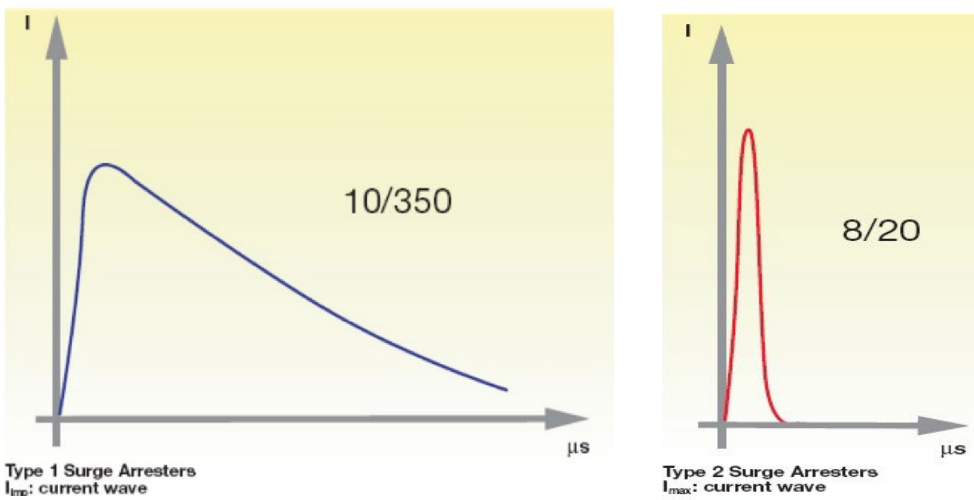

Illustration B: Surge Protection Types

A Type 2 surge arrester (SPD2) should be used in coordination with the incoming Type 1 surge arrester. This is the second stage of protection. The Type 2 Surge arrester is designed to run-off energy caused by an overvoltage comparable to that of an indirect lightning strike or an operating overvoltage (this is effectively the “left-over” surge from the Type 1 protection device). To provide sufficient de-coupling between the Type 1 and Type 2 devices, impedance is required. This is typically stated to be 10m of cable (approximately 10μH). This cable may be looped if the distance available is too short. Alternatively, various manufacturers have devices which act as filter elements or provide active spark ignition for applications where 10m of cable is not practical (such as outdoor enclosures).

Note: NewMar Rectifiers are compliant with EN61000-4-5, Level 4 without any external/upstream surge suppression. To maintain a coordinated approach to surge suppression, Type 2 SPD should be installed upstream if not fitted in the system.



WARNING The fitment of a Type 2 AC Surge Suppression Device is mandatory. If a Type 2 SPD is NOT fitted, the warranty is void.

II.A Upstream Over-Current Protection

There are three considerations to take into account when selecting an appropriate fuse/circuit breaker:

- Firstly, the upstream protection should protect the downstream cable from overload situations,
- Secondly, discrimination should be maintained with the downstream device fuses, and
- Thirdly, protection of the surge suppression devices should be taken into account.

II.B Cable Rating

The maximum current drawn by this DC power system is 52.5A per phase (at minimum input voltage of 185V PhPh and full output power). The upstream protection device must be able to supply this load under all conditions without tripping. Therefore, typically at least 20% headroom is allowed for in the protection device, making its minimum rating 63A. As a result, typically 63A device is used. Therefore, the cable used to supply the system must be rated at the upstream protection device rating. Please see your local wiring regulations for exact requirements, as cable sizes can vary depending on these regulations and on the material the cable’s insulation is made from.

As a comment on rectifier AC feed cable sizes: each rectifier is fed by one set of cables from the AC input terminals. Although in theory it may appear that this smaller wire is unprotected, in fact it is protected on two accounts. Firstly, it is protected by the rectifier input fuse (which is only a short distance away). Secondly, the rectifiers are power-limited on their input. Therefore, they can never be overloaded. As a result, the wire can never be over-loaded by the rectifier – it can only see fault current.

II.C Discrimination

Discrimination ensures that the upstream circuit breaker or fuse does not blow if a rectifier input is faulty (in a short circuit manner). Therefore, it is important to ensure the upstream protection discriminates with the internal fuse of the rectifier. The fuse used in the RM3048 is a slow-blow 25A fuse.

Preferably use either a 50A, D-curve, or a 63A, C or D curve breaker. If a fuse is used upstream, then any BS88 or NH g style fuse will discriminate above 50A. A minimum circuit breaker to use for this system is a 50A.

II.D Surge Suppression Device Protection

It is recommended to have Type 2 Surge Protection Devices (s) (as defined by IEC 61643-11) upstream to the supplied cabinet. These devices are rated for repeated strikes of 20kA (8/20 μ s waveform), and single shot protection of 40kA. It is important that upstream Type 1 protection is also provided on site. To ensure correct operation of the s, at least 10m of AC feeder cable is fitted between the Type 1 and Type 2 protection. If the distance between the AC incoming distribution board and the DC Power System is less than 10m, then loop the cable until at least 10m of cable is used. This ensures correct de-coupling of the devices.

II.E AC cable installation and surge protection

The following precautions MUST be adhered to when installing AC cabling.

1. Avoid running input and output cables from AC Surge Protection Devices together:

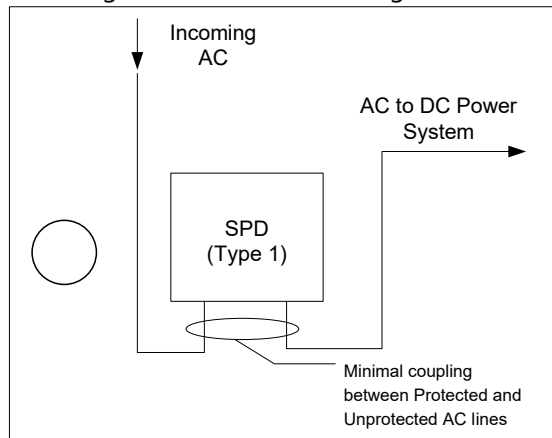
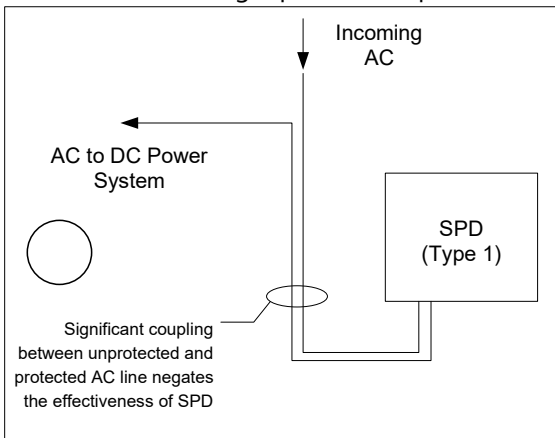

2. Avoid "T" Connections:

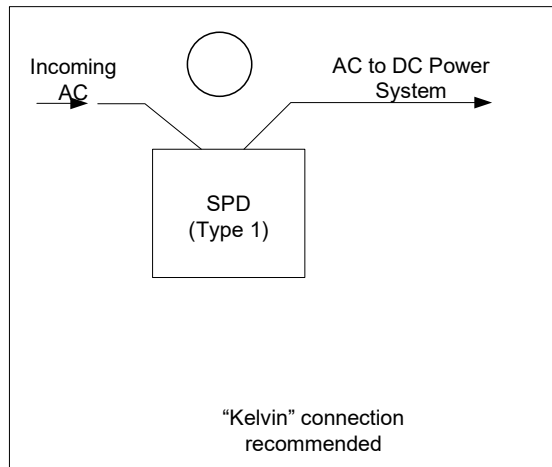
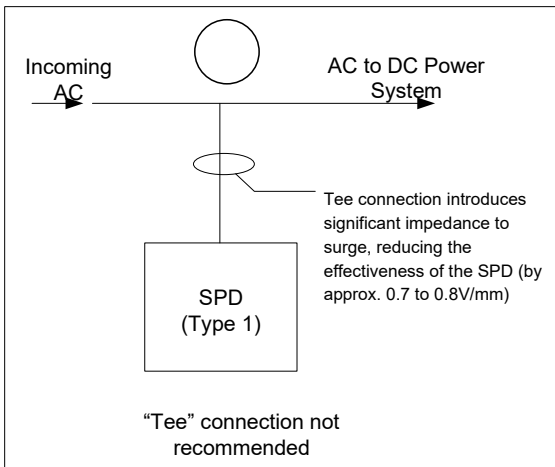

Appendix III NEWMAR ENERGY STANDARD LIMITED WARRANTY POLICY

NewMar warrants that its products shall be free from defects of material or workmanship under use consistent with correct installation and commission, normal operation, product specifications, NewMar's written instructions, and regional standards compliance, for a period of one (1) year from the start date. The start date shall be defined as (a) the date the product is

shipped from NewMar's factory; or (b) in the case of resale by an authorized NewMar reseller, whichever is the lesser of i) the date on the sales invoice or ii) ninety (90) days after original shipment by NewMar factory.

The warranty provides for repairing or replacing, at NewMar's sole discretion, those products deemed defective by NewMar after inspection of its products returned by the customer to the factory or other NewMar authorized location within the warranty period. Replaced product provided by NewMar under the terms of this warranty does not extend the original warranty, replacement product assumes the warranty of the original product. Repaired product or component thereof has a warranty period of ninety (90) days or the remainder of the unexpired term of the original product warranty, whichever is greater.

III.A Warranty Exclusions and Restrictions

Products or parts may be excluded from warranty coverage for reasons including, but not limited to: if the hardware or software has been altered or repaired by an unauthorized party; is defective due to misuse, negligence, accident, mechanical damage, improper installation or maintenance; inappropriate on-site conditions such as high humidity, dust, power surges, out-of-range temperatures, animal or insect damage, water or other liquid damage; where serial numbers or identification marks are removed or defaced in any way; Force Majeure event; has cosmetic shortcomings which do not affect normal operation; inappropriate electrical stress; for suspected fraud or abuse of NewMar's warranty policy; the account has breached or is in dispute of NewMar's commercial terms and conditions.

Note NewMar warranty does not cover data loss, regular back-ups to separate storage is required.

III.B Battery Warranty

Battery warranty is NOT covered under this warranty. Where NewMar supplies batteries a separate warranty statement shall govern the battery warranty, or where an NewMar battery warranty is not provided the authorized battery vendor's warranty shall be assigned to the batteries.

Note that batteries' operational limits are typically more constrained than NewMar manufactured equipment, need specific care during storage and maintenance, and requirements typically vary for each battery type and vendor. NewMar product warranty is voided should improper care of associated batteries be the cause of product defect.

Unless stated otherwise in the terms and conditions of sale warranty for peripherals, attachments or apparatus not manufactured by NewMar shall be excluded from this warranty.

Commander II+

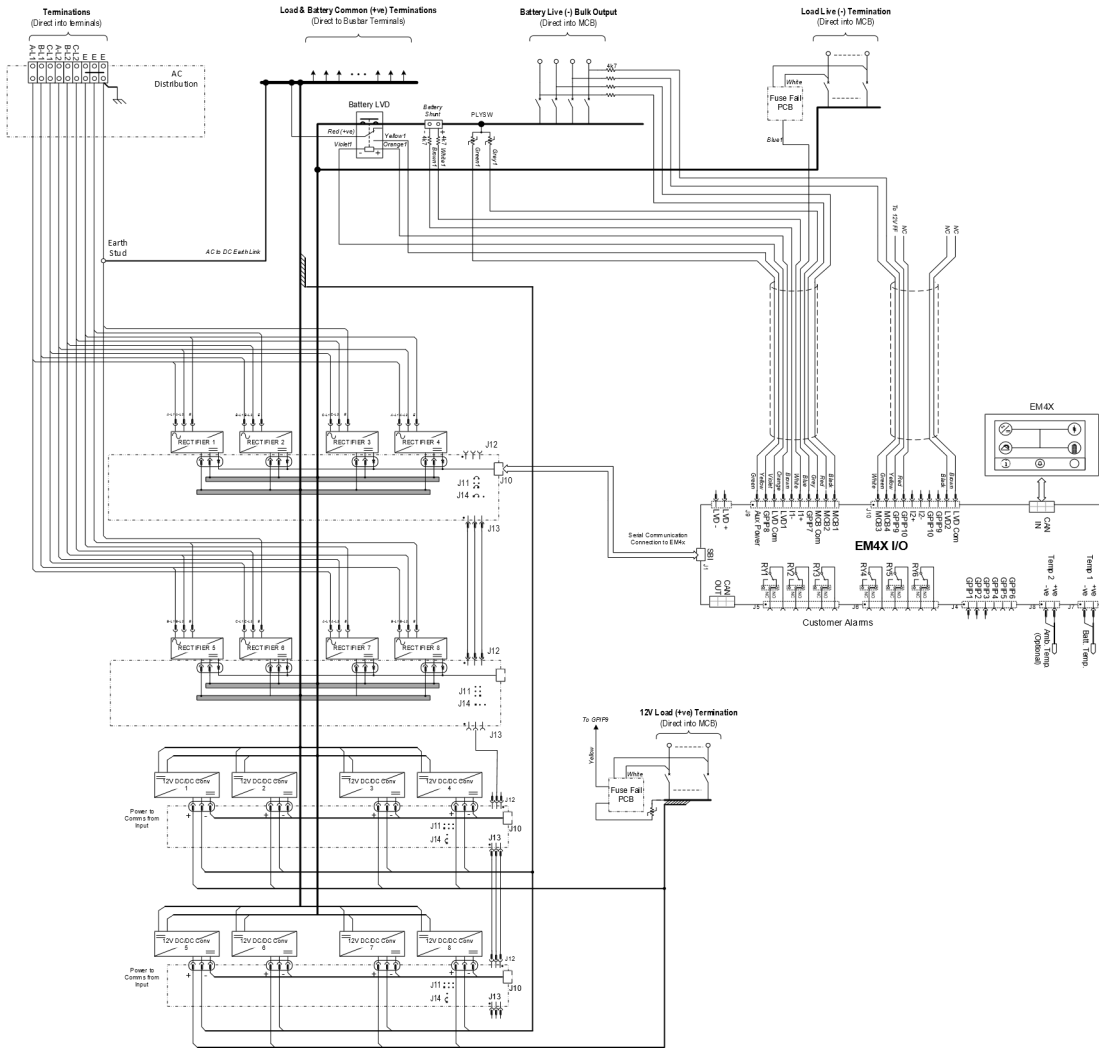

Appendix V Enabling the Ambient Temperature Sensor

To enable the Ambient Temperature Sensor

- Physically connect the ambient temperature sensor (purchased separately) to T2 on the EM4x controller IO board

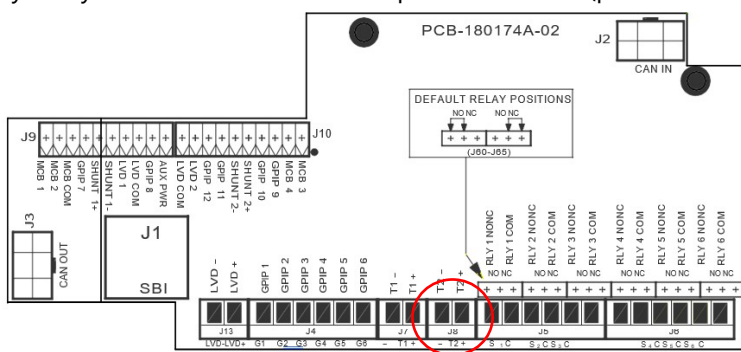

- Login to the controller via the web GUI
- Navigate to the **Input Logic** page, after the last entry press the  icon to add a logic expression
- From the 1st drop down menu, select **Measurement and Controls > Input > Ambient Temperature**
- From the 2nd drop down menu, select **Measurement and Controls > IO Board > IO Board 1 Temperature 2**
- Press the Save button to implement changes
- Navigate to the **Alarm Configuration > Alarm Configuration > General Alarms**
- Expand the **General Alarms** by selecting the +
- Enable the **Ambient Temperature Faulty, Ambient Temperature High, and Ambient Temperature Low** alarms
- Press the Save button to implement changes
- This addition can be accomplished with power to the system enabled. Exercise extreme caution when working with energized equipment. It may be necessary to refresh the browser after completion.

This addition can be accomplished without power to the system by utilizing the USB connection on the front of the controller. Upon completion of the programming, the ambient temperature sensor will show a fault. This is normal as the IO board does not receive power when programmed from the USB without power enabled.

Commander II Series AC Input Wiring Options

Note: AC wiring should only be performed by qualified electrician or technician familiar with AC wiring practices and local electrical code.

Option 1: 208 VAC three Phase w/ three 2 pole circuit breakers

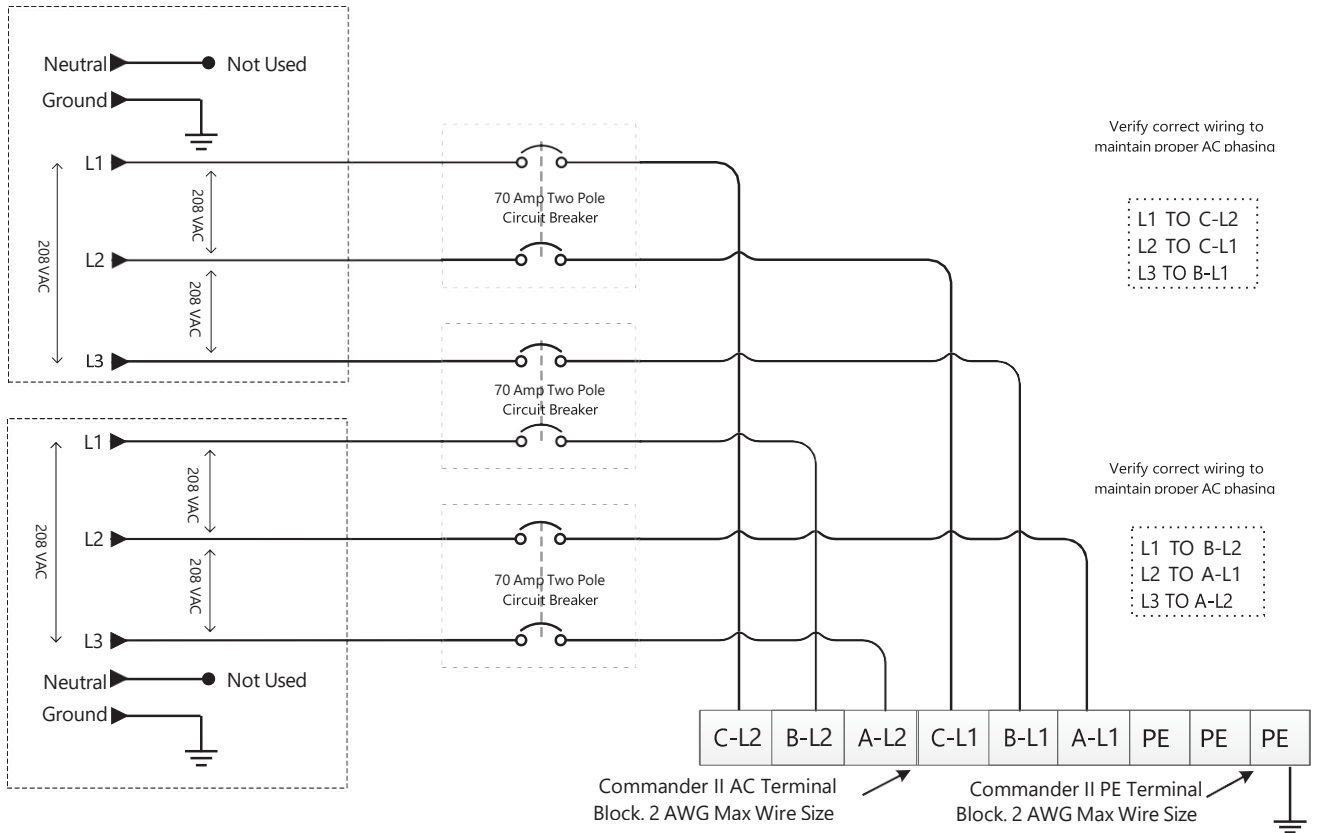

Option 2: 208 VAC Three Phase w/ two 3 pole circuit breakers

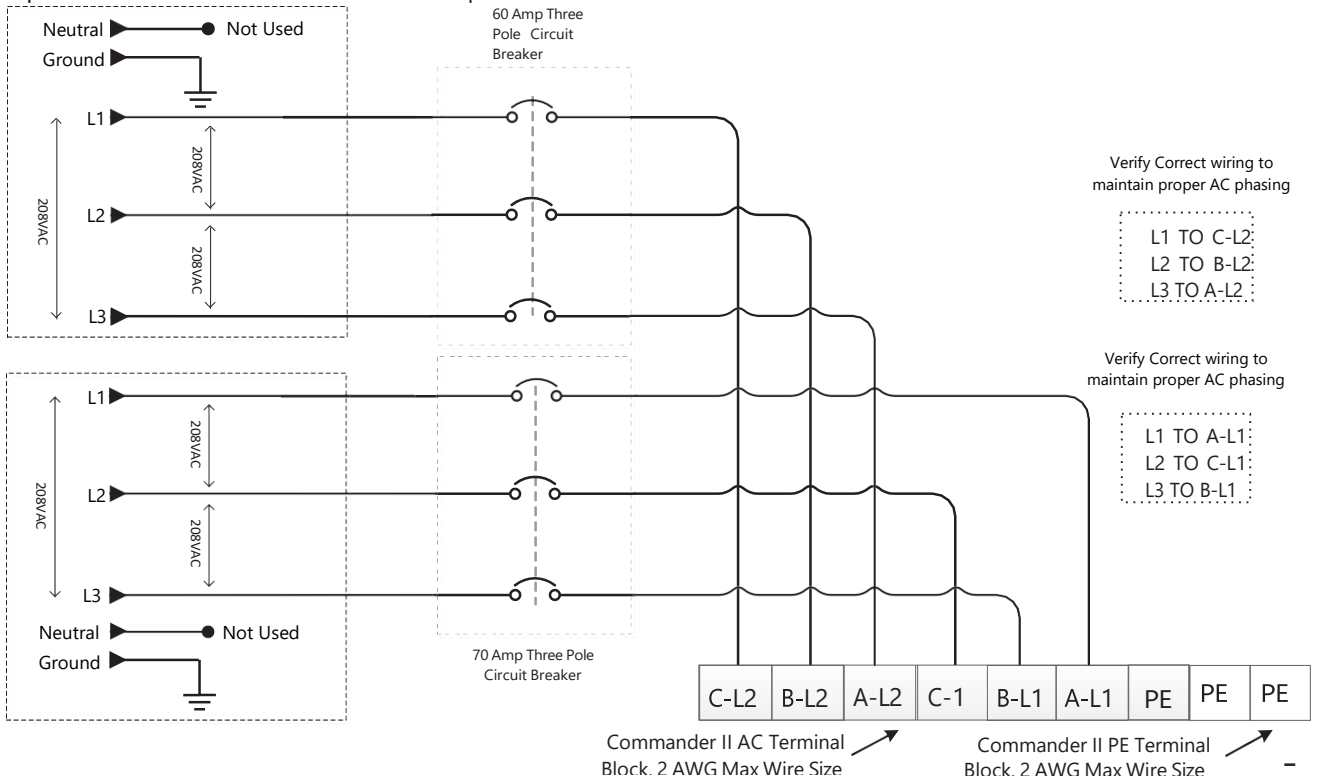

Option 3: Three 230VAC Single/Split Phase Feeds

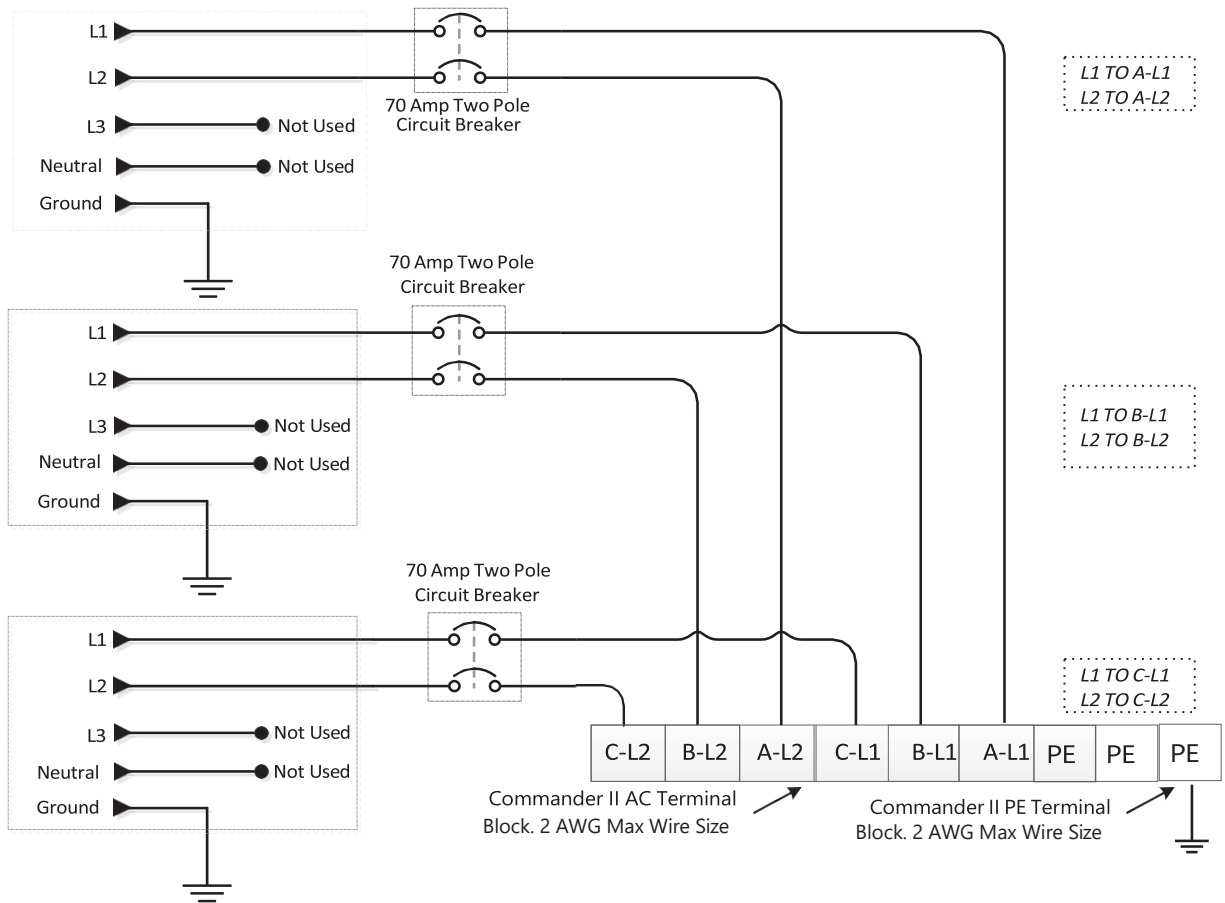

Option 4: Three 230VAC Feeds (Euro)

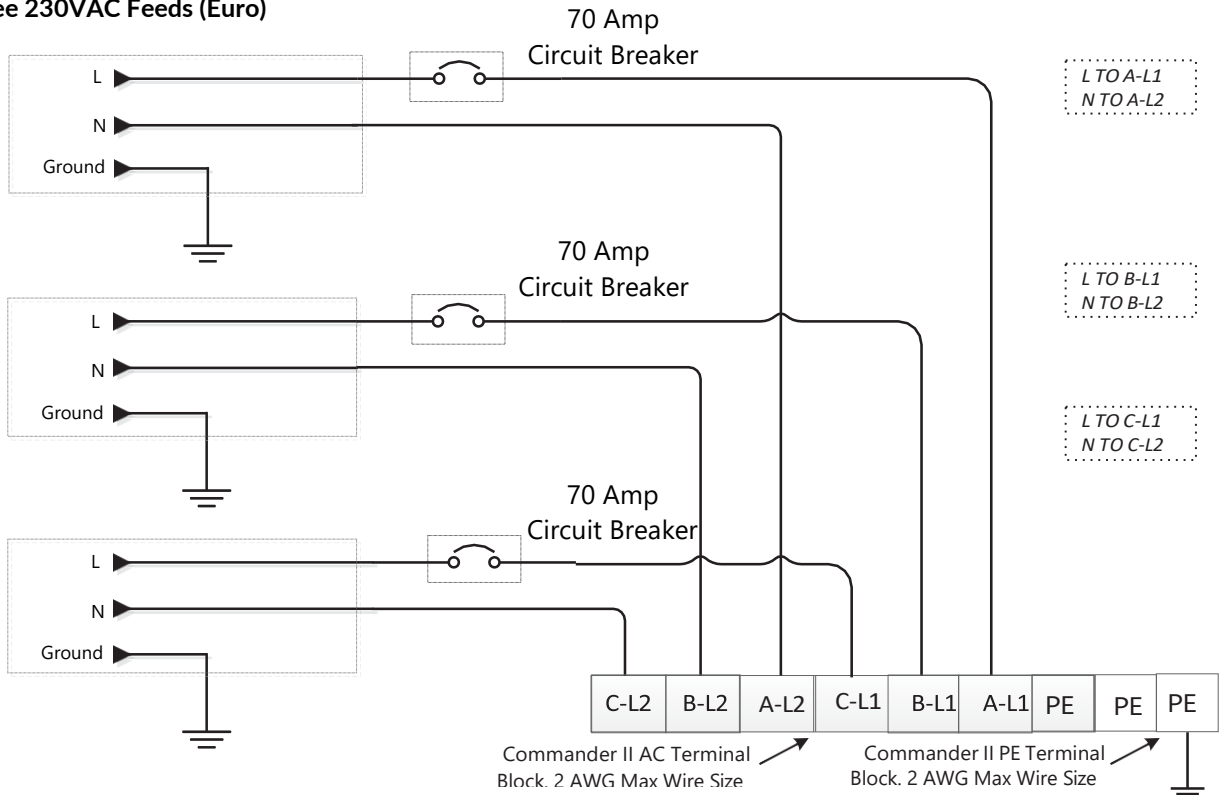

Commander II+ Series AC Input Wiring Options

Note: AC wiring should only be performed by qualified electrician or technician familiar with AC wiring practices and local electrical code.

Option 1: 208 VAC three Phase w/ three 2 pole circuit breakers

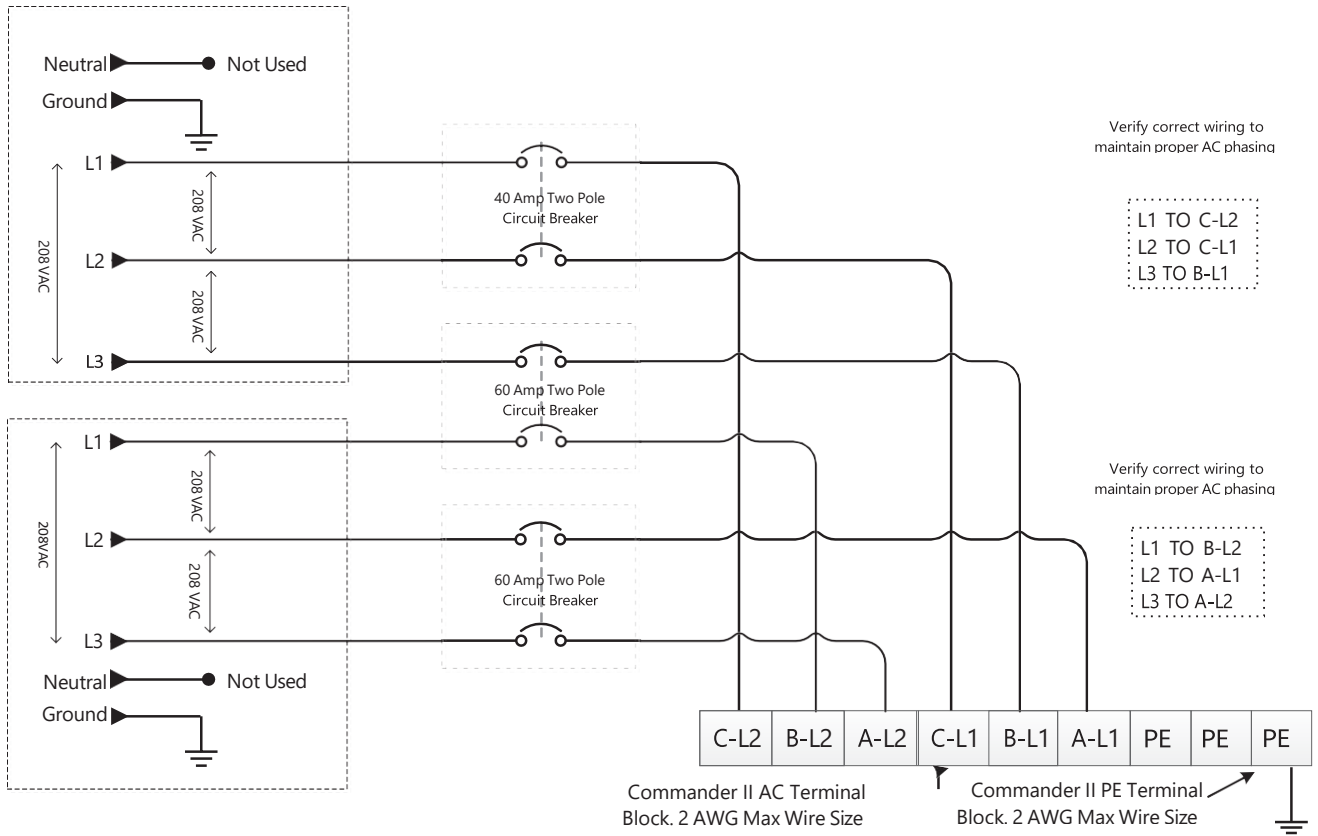

Option 2: 208 VAC Three Phase w/ two 3 pole circuit breakers

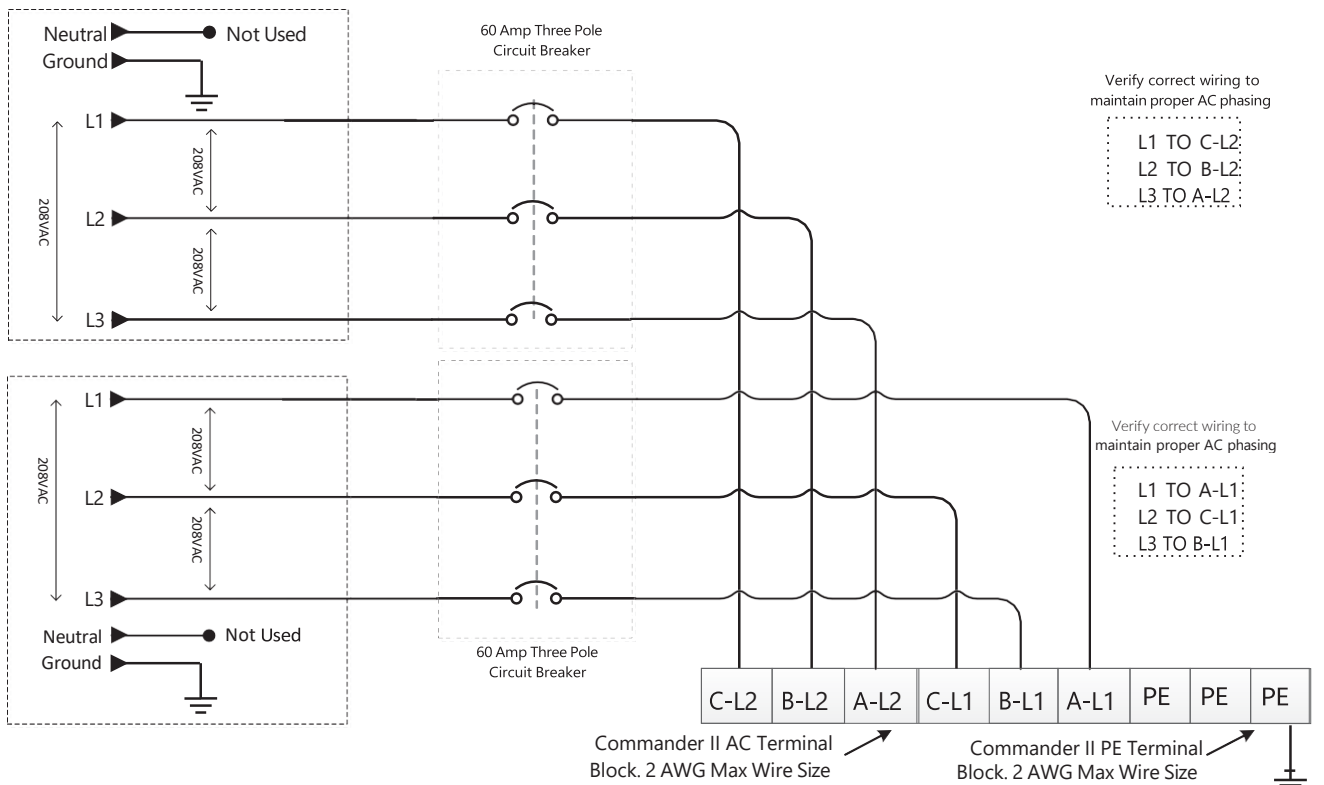

Option 3: Three 230VAC Single/Split Phase Feeds

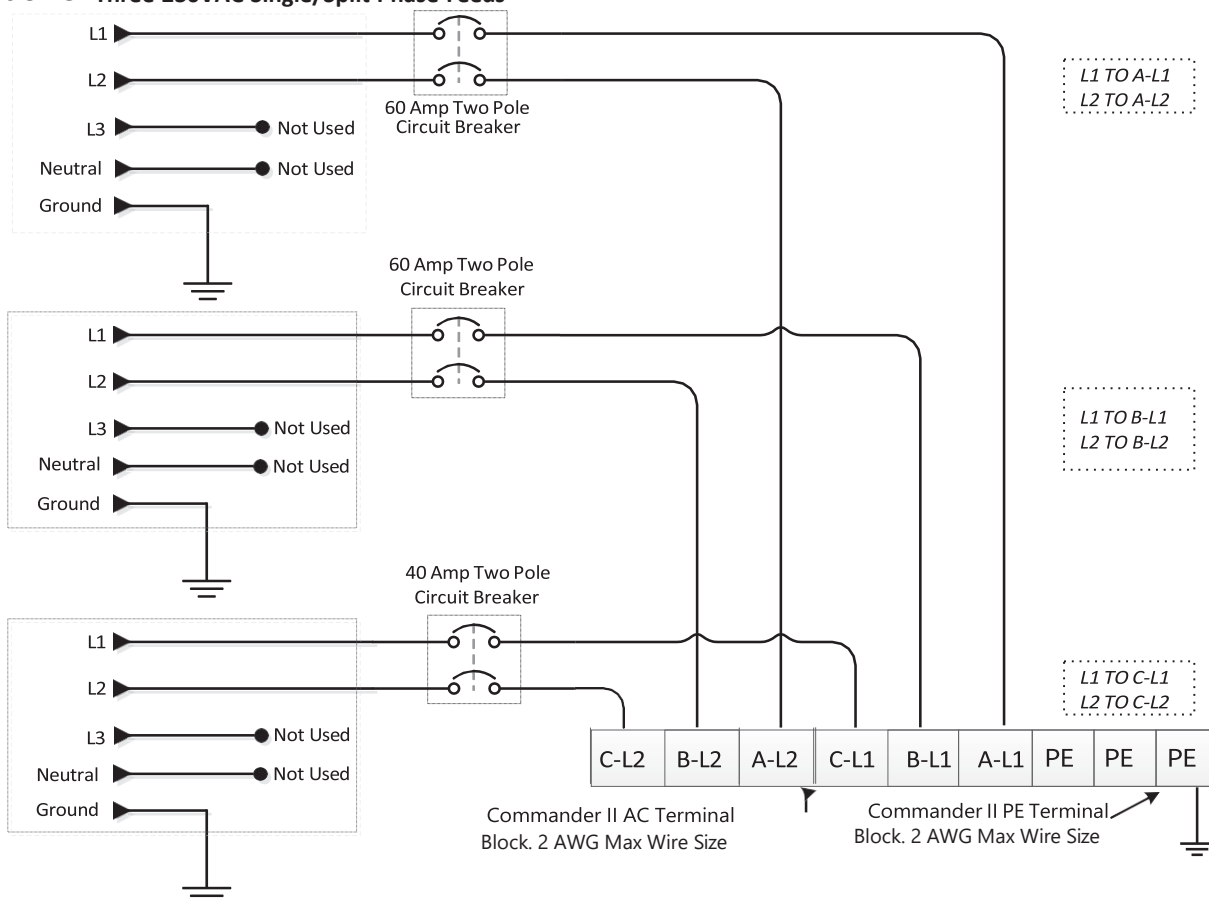

Option 4: Three 230VAC Feeds (Euro)

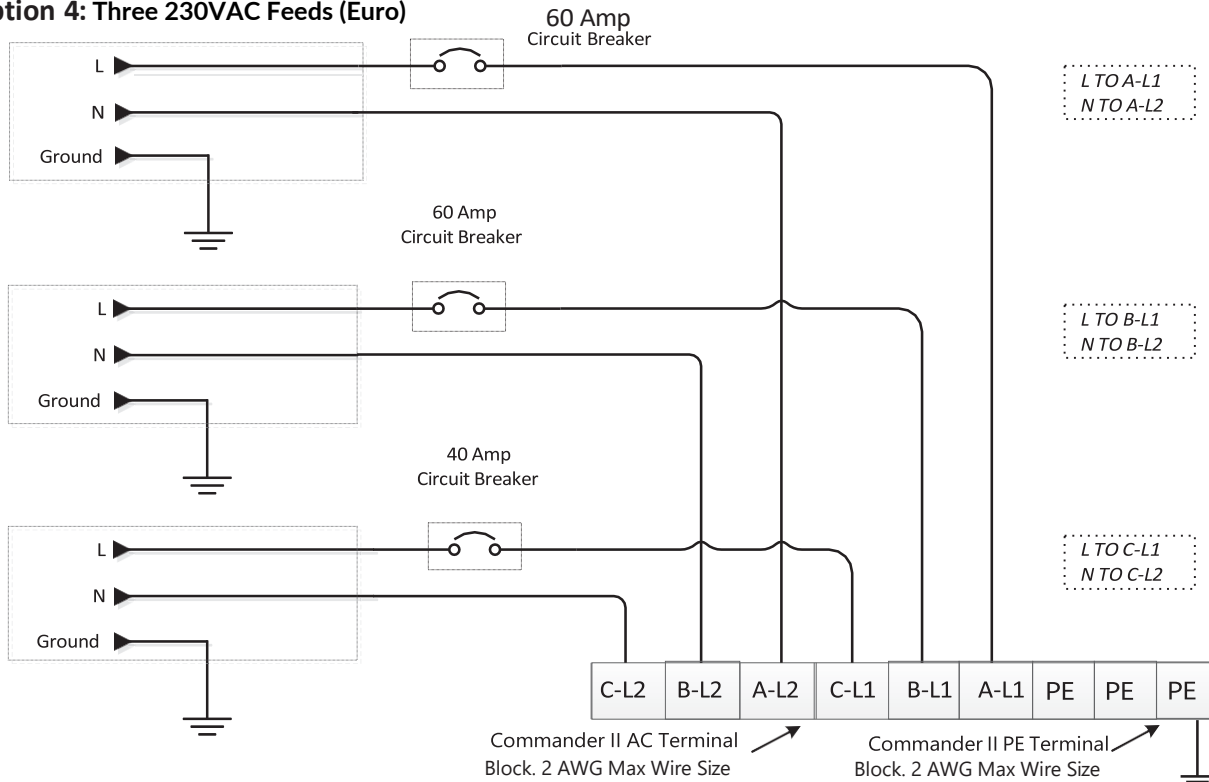

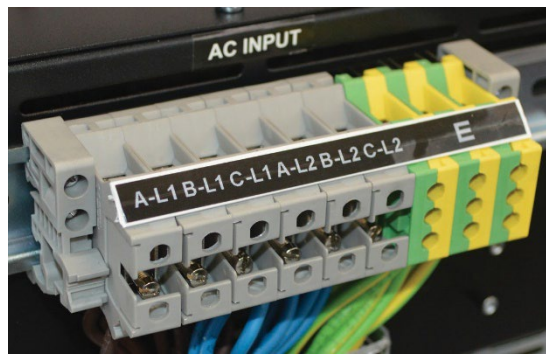

AC Input Terminals

COMMANDER II SERIES SHELF (FRONT)

EACH PAIR OF AC INPUT TERMINALS (L1/L2) FEEDS FOUR RECTIFIER BAYS (COMMANDER II) OR THREE RECTIFIER BAYS (COMMANDER II+). BAYS HIGHLIGHTED IN GREEN ARE ACTIVE.

COMMANDER II



COMMANDER II+

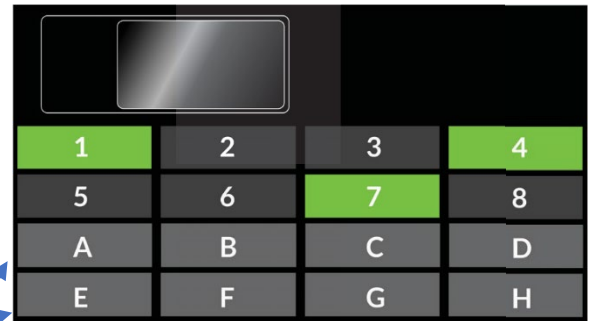

A-L1/A-L2
Input

DC-DC
CONVERTOR BAYS



B-L1/B-L2
Input

DC-DC
CONVERTOR BAYS

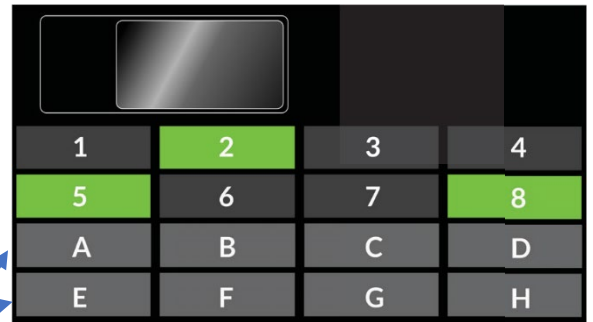

C-L1/C-L2
Input

DC-DC
CONVERTOR BAYS

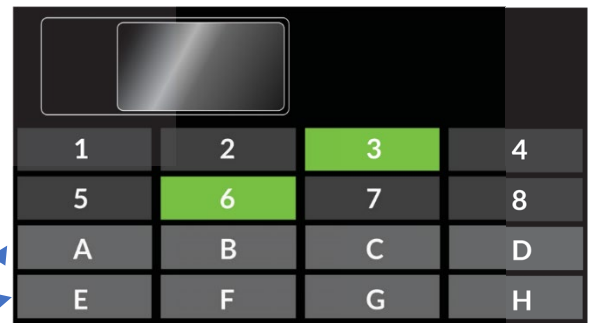

3KW RECTIFIER CURRENT DRAW: @208VAC
= 15.3A @230VAC = 13.9A